

Am188ER MICROCONTROLLER BLOCK DIAGRAM

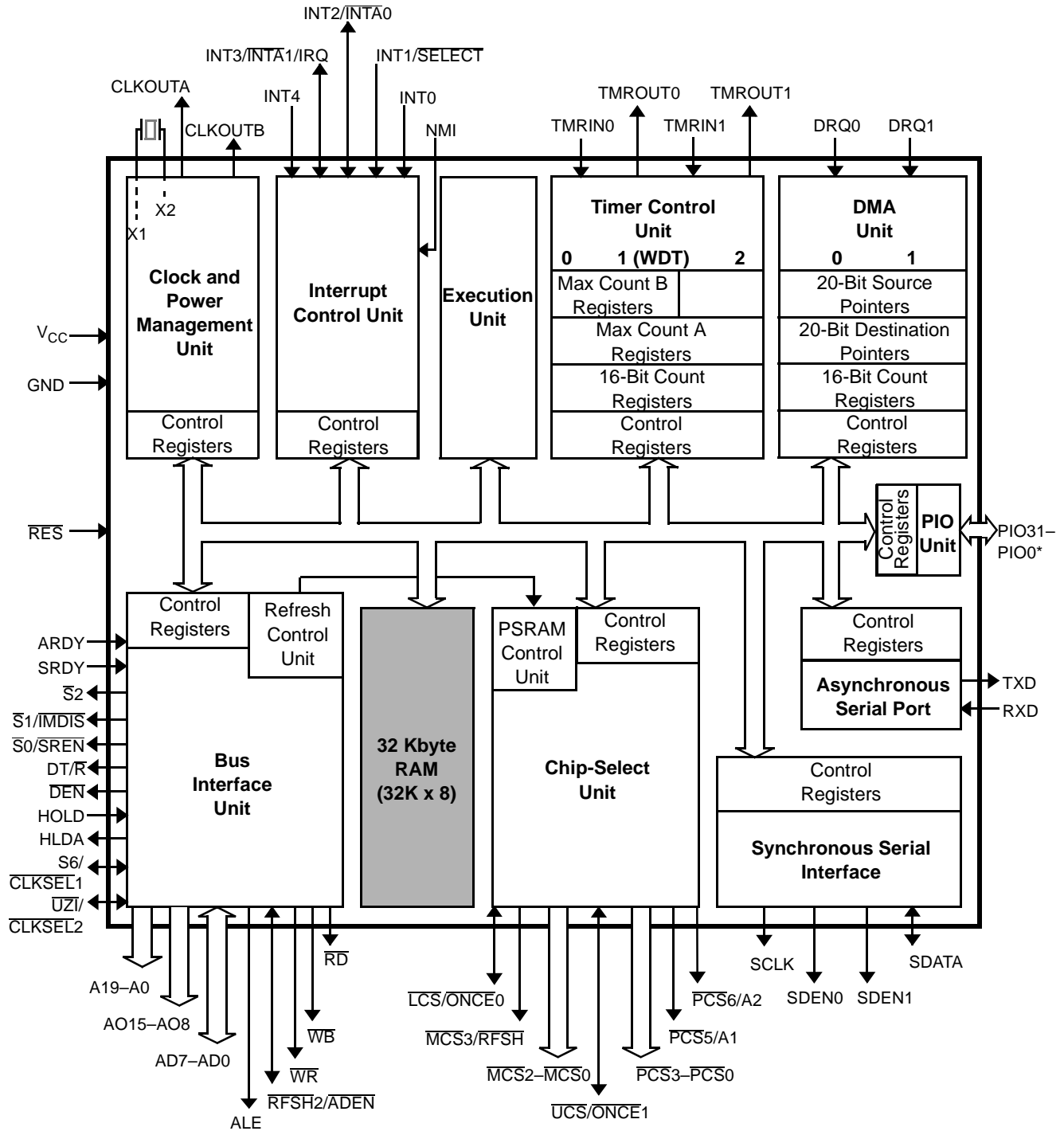

Note:

* All PIO signals are shared with other physical pins. See the pin descriptions beginning on page 26 and Table 2 on page 31 for information on shared functions.