

Introduction

Part Number	Description
B5	16-Channel Digital Brain Pamux

The Pamux® B5 is an addressable digital brain board that can control up to 16 input or output points in distributed I/O applications. The B5 is designed for use with a variety of Opto 22 I/O mounting racks, including racks that accept single-point digital I/O or quad pak digital I/O as well as racks with integrated digital I/O circuitry.

The B5 features a 50-pin female connector to attach to a mounting rack and two 50-pin male connectors to attach to the Pamux bus or a terminator board. Up to 32 B5 brain boards may be linked on a single Pamux bus to control up to 512 points of digital I/O. Each B5 requires 5 VDC ± 0.1 V @ 0.5 A (plus an additional 0.5 A if a terminator board is installed).

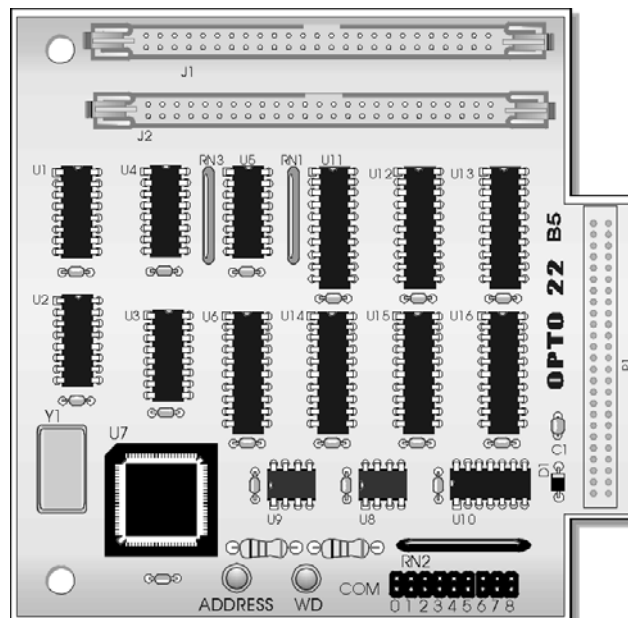

Figure 1: B5 Brain Board

This document describes how to install the B5 digital I/O brain board on a compatible mounting rack. It discusses all B5 configuration issues, including how to set jumpers for the address, watchdog, and reset line. It also explains how to install a terminator board when a B5 station is at one end of a Pamux system. Finally, it describes the LED indicators on the B5 and provides information on Opto 22 Product Support.

For complete information on the Pamux system, call Opto 22 at 800/321-6786 and request the *Pamux User's Guide* (form 726).

Installing the B5 on a Mounting Rack

The B5 brain board measures 4.6 by 4.5 inches. It includes a 50-pin female connector to attach to a digital I/O mounting rack. At the top of the brain board are two 50-pin male header connectors used to link the brain board to the Pamux bus. For the last brain board on a Pamux bus, one of these connectors holds the terminator board.

Figure 2 is a detailed illustration of the B5 along with its dimensions.

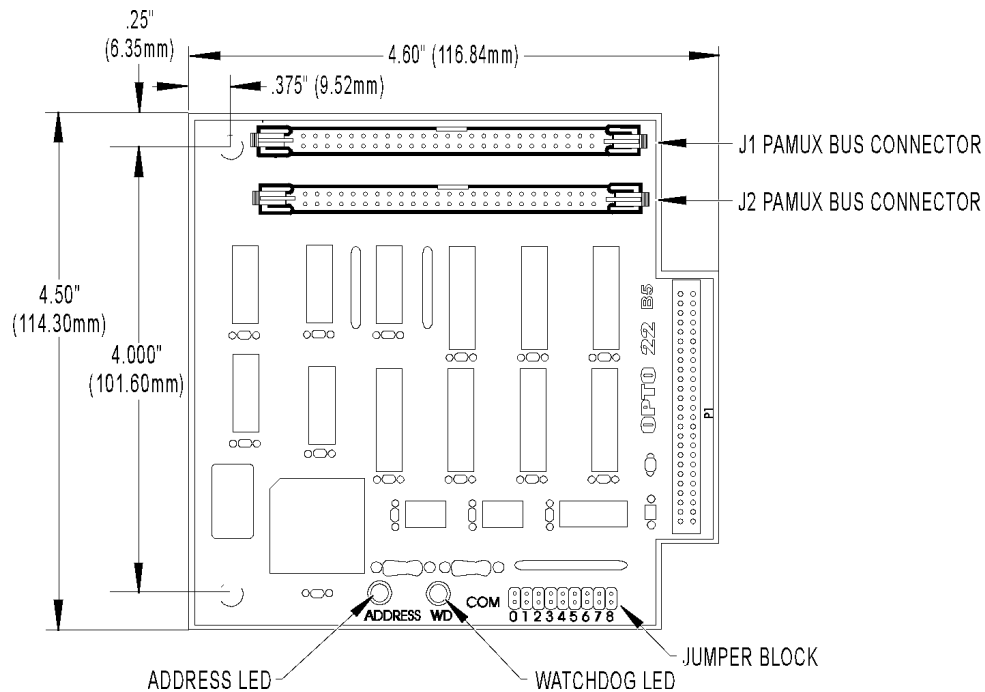

Figure 2: Dimensions of the B5 Brain Board

The following I/O mounting racks are available for the Pamux B5 brain board:

- G4PB8H — 8 channels of single-point G4 digital I/O
- G4PB16H — 16 channels of single-point G4 digital I/O
- G4PB16HC — 16 channels of single-point G4 digital I/O
- G4PB16J/K/L — 16 channels of integrated single-point digital inputs
- PB4H — 4 channels of single-point standard digital I/O
- PB8H — 8 channels of single-point standard digital I/O
- PB16H — 16 channels of single-point standard digital I/O
- PB16HC — 16 channels of single-point standard digital I/O
- PB16HQ — 4 channels of quad pak I/O (four points per module)
- PB16J/K/L — 16 channels of integrated single-point digital inputs

Figure 3 shows how the B5 brain board mounts on these racks.

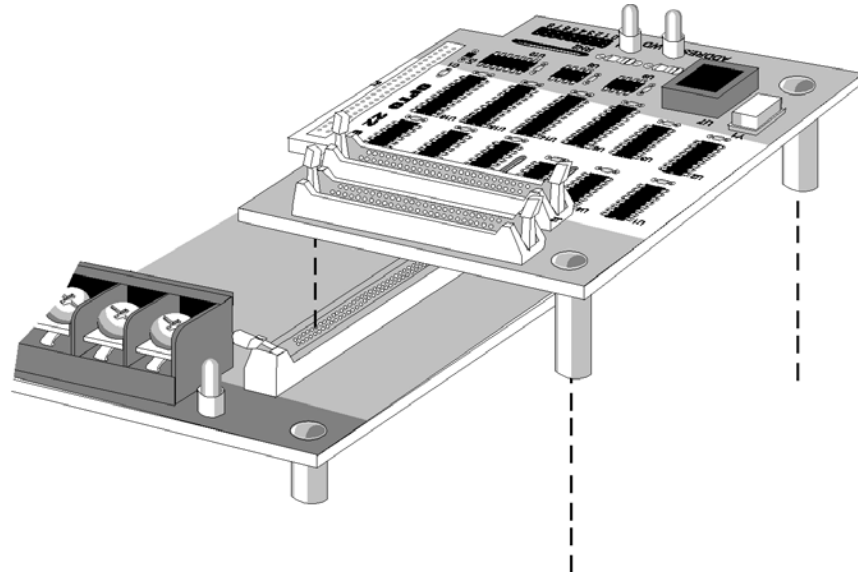

Figure 3: Installation of the B5 on a Mounting Rack

Figures 4 through 13 show the mounting dimensions of these racks with the B5 brain board installed.

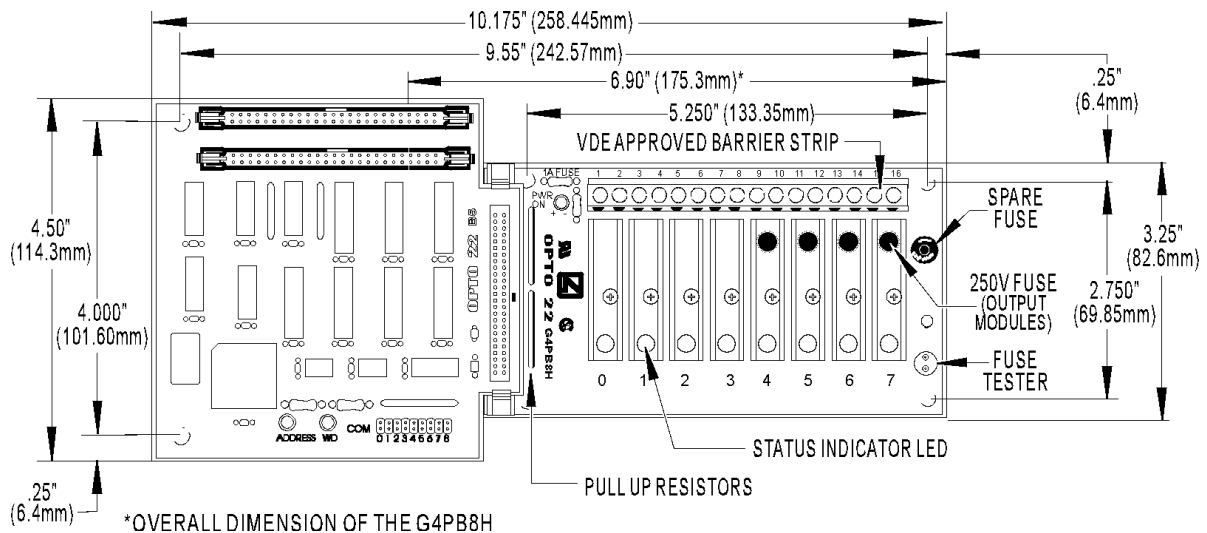

Figure 4: Mounting Dimensions of the G4PB8H with a B5 Installed

OPTO 22

DATA SHEET

Form 738-050801

BRAIN BOARDS CLASSIC PAMUX INSTALLATION NOTES

page 4/13

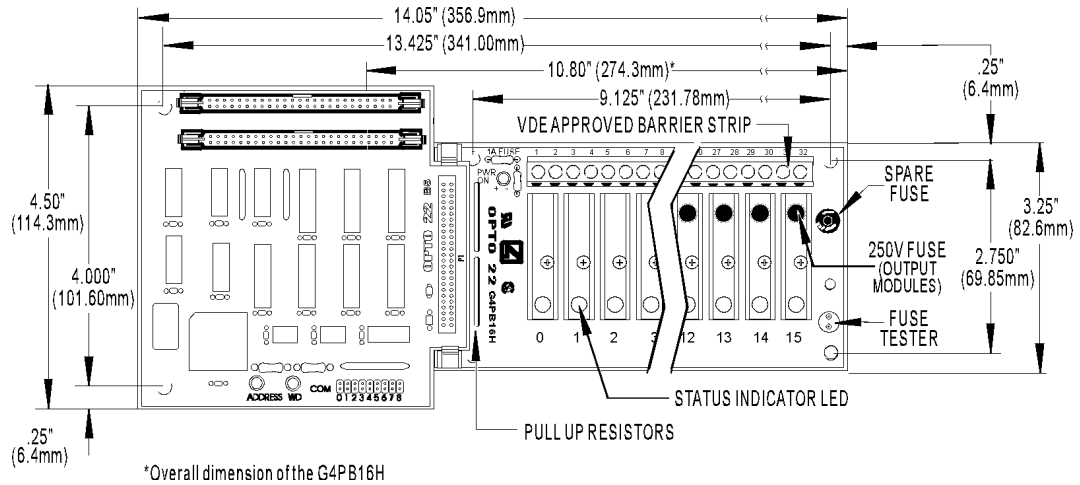

Figure 5: Mounting Dimensions of the G4PB16H with a B5 Installed

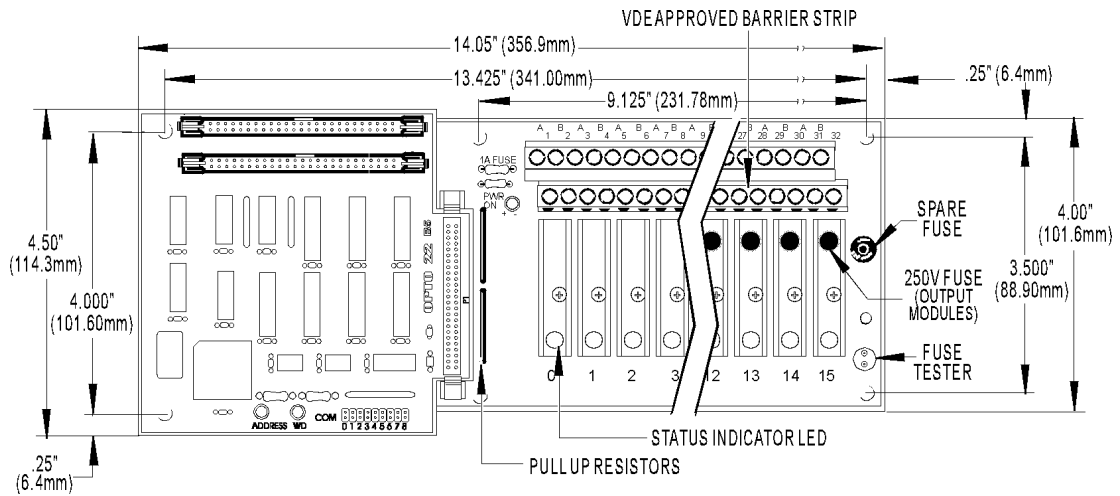

Figure 6: Mounting Dimensions of the G4PB16HC with a B5 Installed

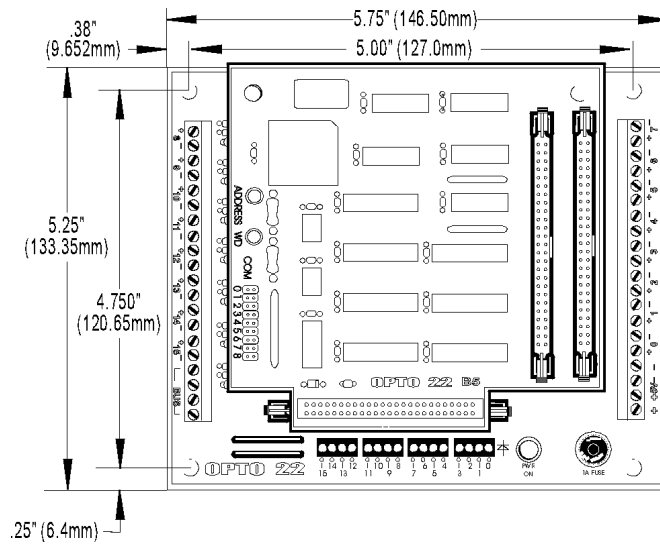

Figure 7: Mounting Dimensions of the G4PB16J/K/L with a B5 Installed

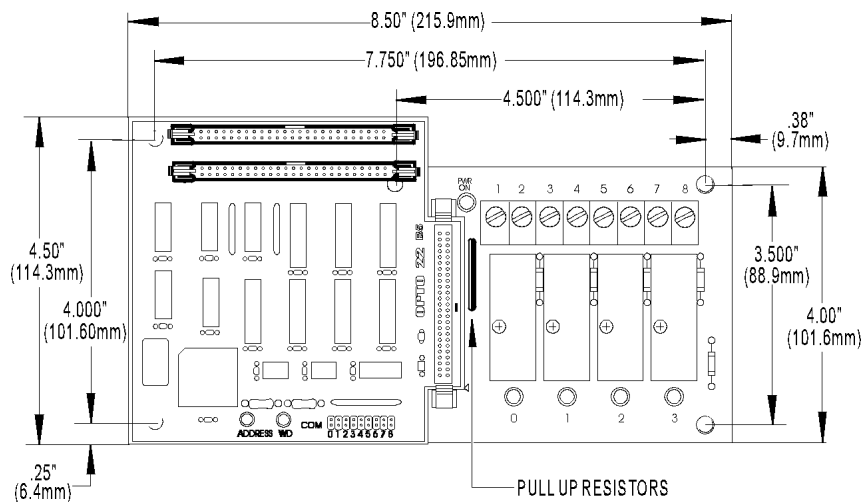

Figure 8: Mounting Dimensions of the PB4H with a B5 Installed

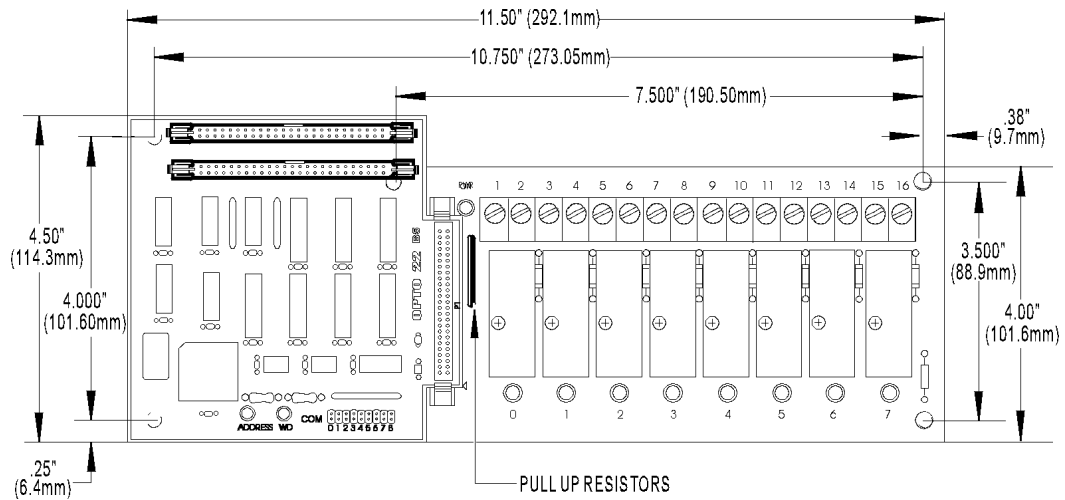

Figure 9: Mounting Dimensions of the PB8H with a B5 Installed

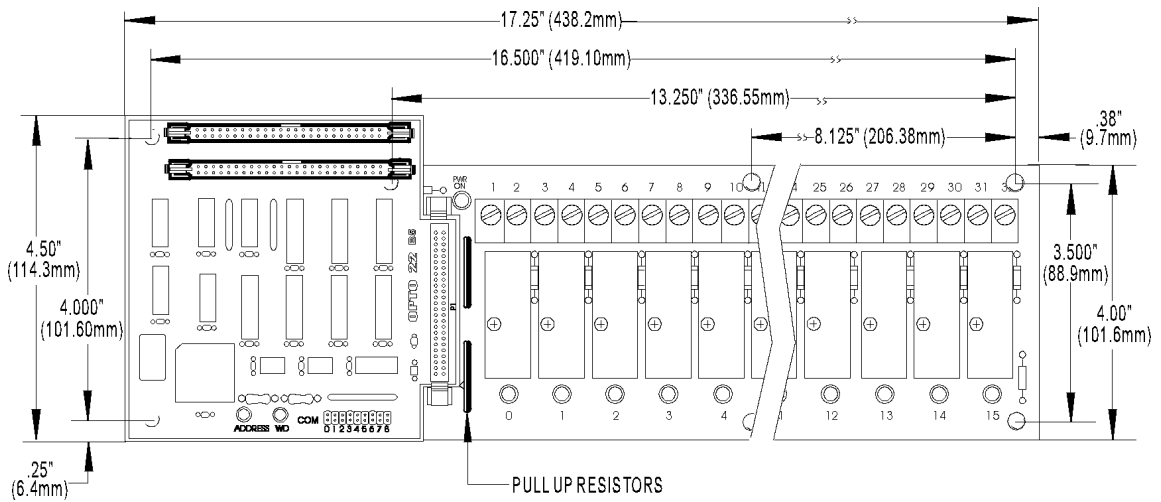

Figure 10: Mounting Dimensions of the PB16H with a B5 Installed

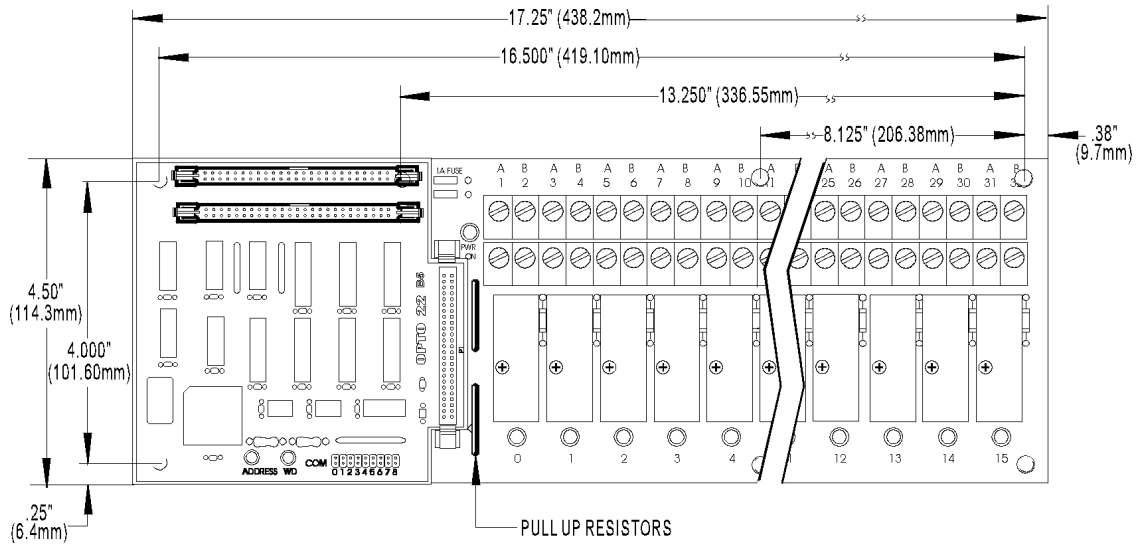

Figure 11: Mounting Dimensions of the PB16HC with a B5 Installed

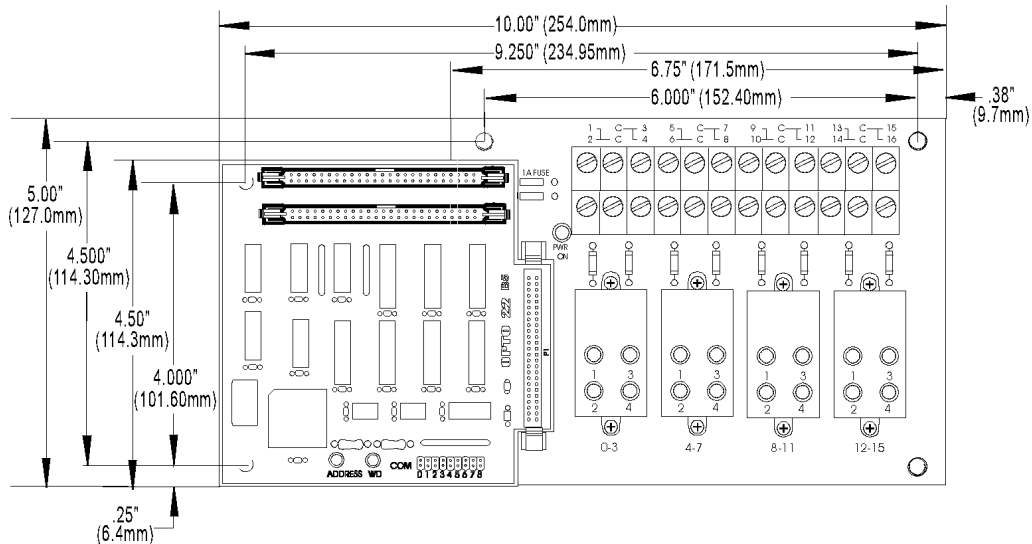

Figure 12: Mounting Dimensions of the PB16HQ with a B5 Installed

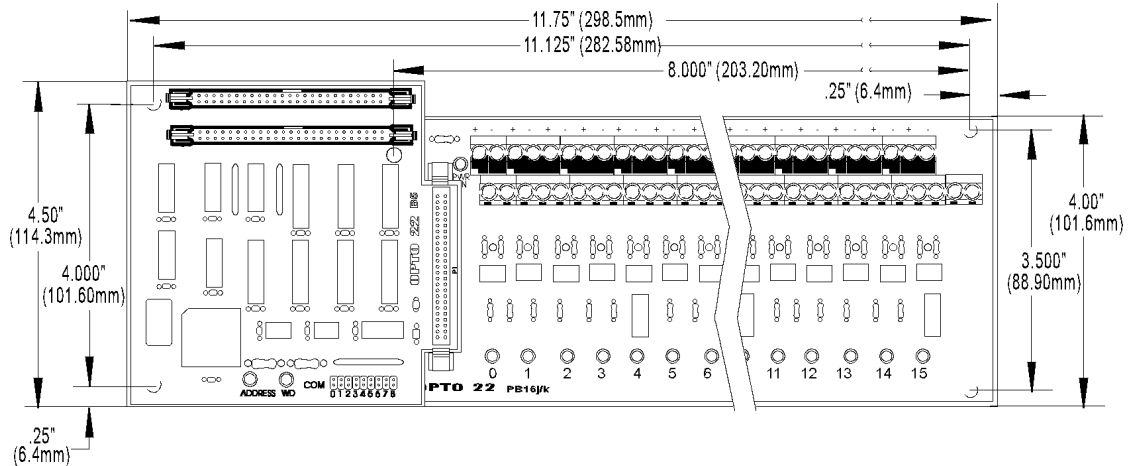

Figure 13: Mounting Dimensions of the PB16J/K/L with a B5 Installed

Figure 14 shows the vertical dimensions of the B5 mounted on any rack except the PB16HQ.

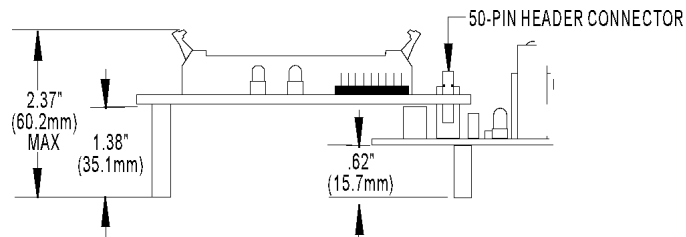

Figure 14: Vertical Dimensions of the B5 Mounted on Racks Other than the PB16HQ

Figure 15 shows the vertical dimensions of the B5 mounted on the PB16HQ. This rack accepts quad pak modules, which are taller than standard digital I/O modules.

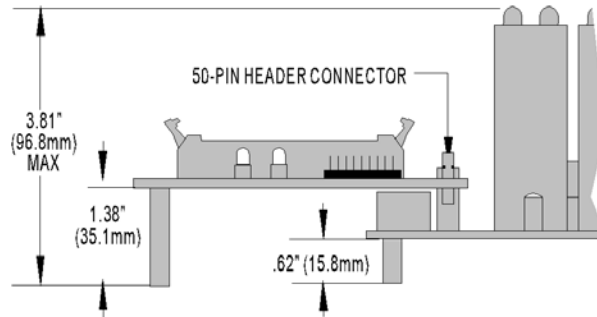

Figure 15: Vertical Dimensions of the B5 Mounted on a PB16HQ

Setting the Jumpers

The B5 includes nine jumpers. Jumpers 0 through 4 set the address, jumpers 5 and 6 set the watchdog functionality, jumper 7 sets the reset line polarity, and jumper 8 determines how the reset line affects the watchdog timer.

Jumpers 0-4 (Address)

These jumpers configure the base address of the B5. Since the brain board controls 16 points of I/O, while the Pamux data bus is only eight bits wide, the B5 must be accessed as two consecutive banks of eight I/O channels each. The least significant bit of the Pamux address bus is used to select which bank is accessed (0 = low bank, 1 = high bank). The other 5 bits of the Pamux bus address determine which Pamux station is active.

Refer to Table 2 on the followings page to determine how to set the base address of the B5.

Note that each Pamux station on a bus must have a unique address.

Jumpers 5 and 6 (Watchdog)

A watchdog timer shuts down a process when the host computer goes off line. The watchdog timer on the B5 depends on a periodic read or write strobe from the host processor. The individual B5 need not be addressed. The absence of a strobe for a specified time activates the watchdog function.

Using jumpers 5 and 6, you can configure the B5 to trigger one of four actions upon a time-out. Refer to Table 1 below.

Table 1: Watchdog Jumpers

Watchdog Function	Jumper 6	Jumper 5
No action	In	In
Activate relay channel 0	In	Out
Deactivate all relay channels	Out	In
Activate relay channel 0 and deactivate relay channels 1-15	Out	Out

DATA SHEET

Form 738-050801

Table 2: Address Jumpers

Base Address	Jumper 4	Jumper 3	Jumper 2	Jumper 1	Jumper 0
0	Out	Out	Out	Out	Out
2	Out	Out	Out	Out	In
4	Out	Out	Out	In	Out
6	Out	Out	Out	In	In
8	Out	Out	In	Out	Out
10	Out	Out	In	Out	In
12	Out	Out	In	In	Out
14	Out	Out	In	In	In
16	Out	In	Out	Out	Out
18	Out	In	Out	Out	In
20	Out	In	Out	In	Out
22	Out	In	Out	In	In
24	Out	In	In	Out	Out
26	Out	In	In	Out	In
28	Out	In	In	In	Out
30	Out	In	In	In	In
32	In	Out	Out	Out	Out
34	In	Out	Out	Out	In
36	In	Out	Out	In	Out
38	In	Out	Out	In	In
40	In	Out	In	Out	Out
42	In	Out	In	Out	In
44	In	Out	In	In	Out
46	In	Out	In	In	In
48	In	In	Out	Out	Out
50	In	In	Out	Out	In
52	In	In	Out	In	Out
54	In	In	Out	In	In
56	In	In	In	Out	Out
58	In	In	In	Out	In
60	In	In	In	In	Out
62	In	In	In	In	In

The watchdog time-out interval is set within the hardware and cannot be changed by the user. Refer to Table 3 for minimum, typical, and maximum watchdog time-out values.

Table 3: Watchdog Time-out Values

Minimum	Typical	Maximum
1.0 sec	1.6 sec	2.25 sec

Jumpers 7 and 8 (Reset)

One of the control lines on the Pamux bus is the reset line. This line is used for turning off the relays on all Pamux stations on the bus. Note that the reset is not intended to be used to shut off outputs upon a system communication error.

Two jumpers control how the reset line affects the B5. Jumper 7 determines the polarity of the reset line, either active high or active low, as shown in Table 2-5. In general, it does not matter which polarity you select as long as you are consistent throughout your Pamux system.

Table 4: Reset Jumper

Reset Level	Jumper 7
Active High	In
Active Low	Out

Jumper 8 determines how the reset line affects the watchdog timer function of channel 0.

If jumper 8 is not installed, the reset line will not affect the watchdog timer function. Hence, if channel 0 activates due to a watchdog condition, an active reset line will have no effect on channel 0 (although it will deactivate any other channels that are on).

If jumper 8 is installed and the watchdog jumpers are configured to activate channel 0 upon a time-out, the state of channel 0 depends on whether or not the reset activates before the time-out occurs:

- If the reset line activates first, all outputs will deactivate. If a subsequent time-out occurs, no effect will take place until the reset line deactivates, at which time the watchdog function will take place and channel 0 will activate.
- If the time-out occurs first, the watchdog function takes place and channel 0 activates. If a subsequent reset occurs, channel 0 will not be affected and will remain active.

Terminating a B5 Station

For stations on a Pamux bus to operate correctly, both ends of the bus must be terminated. The host computer and the last Pamux station on the bus are the only devices that should be terminated. Note that if you are using an Opto 22 Pamux adapter card, the host computer is automatically terminated, since termination resistors are built into the card.

To terminate a B5 station, plug a Pamux bus terminator board (TERM1 or TERM2) into either connector on the brain board. When the terminator board is installed correctly, its component side faces away from the brain board components and its red wire connects to the +5V terminal on the rack.

Figure 16 illustrates the proper installation of the terminator board.

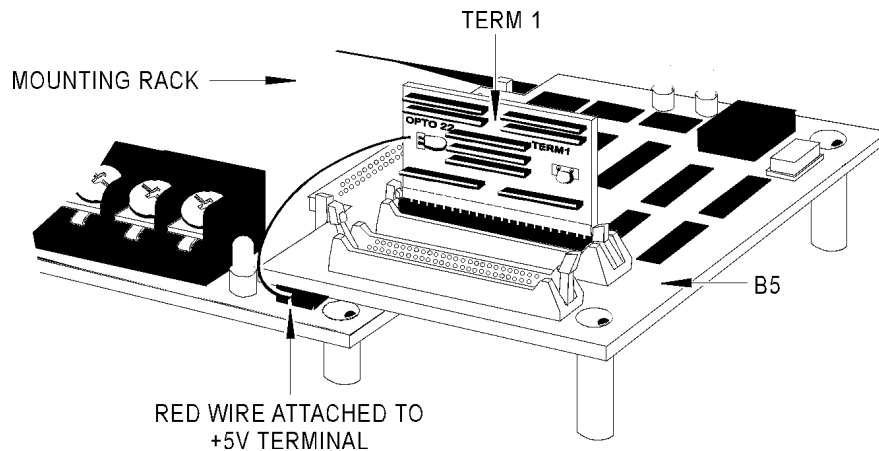

Figure 16: Terminator Board Installed on a B5-Compatible Mounting Rack

LED Indicators

The B5 brain board includes the following LEDs:

- **Address** — This LED is on whenever the brain board is addressed (read from or written to) on the Pamux bus. It is off otherwise. For each operation the LED stays on for about 250 msec, so if the bus is very active the LED may appear constantly on.
- **Watchdog** — This LED stays on if the Pamux bus is idle (no strobe is present) for more than 1.2 seconds. It is off otherwise. Note that unlike the Select LED, this LED monitors overall bus activity.

Product Support

If you have any questions about Pamux products, contact Opto 22 Product Support Monday through Friday, 8 a.m. to 5 p.m. Pacific Time.

Phone: 800/TEK-OPTO (835-6786)
951/695-3080

Fax: 951/695-3017

E-mail: support@opto22.com

Opto 22 Web Site www.opto22.com

When accessing the BBS, use the following modem settings:

- No parity, 8 data bits, 1 stop bit
- Baud rates up to 28,800
- Z-modem protocol (optional but recommended for uploads and downloads)

When calling for technical support, be prepared to provide the following information about your system to the Product Support engineer:

- Software being used
- PC configuration
- A complete description of your hardware system, including:
 - jumper configuration
 - brain boards being used
- Specific error messages

Products

Opto 22 produces a broad array of reliable, flexible hardware and software products for industrial automation, remote monitoring, enterprise data acquisition, and machine-to-machine (M2M) applications.

SNAP Ethernet Systems

Based on the Internet Protocol (IP), SNAP Ethernet systems offer flexibility in their network connectivity and in the software applications they work with. The physical network may be a wired Ethernet network, a cellular wireless network, or a modem. A wide variety of software applications can exchange data with SNAP Ethernet systems, including:

- Opto 22's own ioProject™ suite of control and HMI software
- Manufacturing resource planning (MRP), enterprise management, and other enterprise systems
- Human-machine interfaces (HMIs)
- Databases
- Email systems
- OPC client software
- Custom applications
- Modbus/TCP software and hardware.



SNAP Ethernet system hardware consists of controllers and I/O units. Controllers provide central control and data distribution. I/O units provide local connection to sensors and equipment.

SNAP OEM Systems

Opto 22 SNAP OEM I/O systems are highly configurable, programmable processors intended for OEMs, IT professionals, and others who need to use custom software with Opto 22 SNAP I/O modules.

Linux® applications running on these systems can read and write to analog, simple digital, and serial I/O points on SNAP I/O modules using easily implemented file-based operations. Applications can be developed using several common development tools and environments, including C or C++, Java, and shell scripts.



M2M Systems

Machine-to-machine (M2M) systems connect your business computer systems to the machines, devices, and environments you want to monitor, control, or collect data from. M2M systems often use wireless cellular communications to link remote facilities to central systems over the Internet, or to provide monitoring and control capability via a cellular phone.

Opto 22's Nvio™ systems include everything you need for M2M—interface and communications hardware, data service plan, and Web portal—in one easy-to-use package. Visit nvio.opto22.com for more information.

Opto 22 Software

Opto 22's ioProject and FactoryFloor® software suites provide full-featured and cost-effective control, HMI, and OPC software to power your Opto 22 hardware. These software applications help you develop control automation solutions, build easy-to-use operator interfaces, and expand your manufacturing systems' connectivity.



Quality

In delivering hardware and software solutions for worldwide device management and control, Opto 22 retains the highest commitment to quality. We do no statistical testing; each product is made in the U.S.A. and is tested twice before leaving our 160,000 square-foot manufacturing facility in Temecula, California. That's why we can guarantee solid-state relays and optically-isolated I/O modules *for life*.

Product Support

Opto 22's Product Support Group offers comprehensive technical support for Opto 22 products. The staff of support engineers represents years of training and experience, and can assist with a variety of project implementation questions. Product support is available in English and Spanish from Monday through Friday, 7 a.m. to 5 p.m. PST.

Opto 22 Web Sites

- www.opto22.com
- nvio.opto22.com
- www.internetio.com (live Internet I/O demo)

Other Resources

- OptoInfo CDs
- Custom integration and development
- Hands-on customer training classes.



About Opto 22

Opto 22 manufactures and develops hardware and software products for industrial automation, remote monitoring, enterprise data acquisition, and machine-to-machine (M2M) applications. Using standard, commercially available Internet, networking, and computer technologies, Opto 22's input/output and control systems allow customers to monitor, control, and acquire data from all of the mechanical, electrical, and electronic assets that are key to their business operations. Opto 22's products and services support automation end users, OEMs, and information technology and operations personnel.

Founded in 1974 and with over 85 million Opto 22-connected devices deployed worldwide, the company has an established reputation for quality and reliability.