

RS/6000 7013 500 Series

# Operator Guide

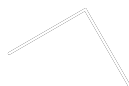

## First Edition (November 1996)

This edition notice applies to the *7013 500 Series Operator Guide*.

**The following paragraph does not apply to the United Kingdom or any country where such provisions are inconsistent with local law:** THIS PUBLICATION IS PRINTED "AS IS" WITHOUT WARRANTY OF ANY KIND, EITHER EXPRESS OR IMPLIED, INCLUDING, BUT NOT LIMITED TO, THE IMPLIED WARRANTIES OF MERCHANTABILITY OR FITNESS FOR A PARTICULAR PURPOSE. Some states do not allow disclaimer of express or implied warranties in certain transactions; therefore, this statement may not apply to you.

This publication could include technical inaccuracies or typographical errors. Changes are periodically made to the information herein; these changes will be incorporated in new editions of the publication. The manufacturer may make improvements and/or changes in the product(s) and/or the program(s) described in this publication at any time.

It is possible that this publication may contain reference to, or information about, products (machines and programs), programming, or services that are not announced in your country. Such references or information must not be construed to mean that such products, programming, or services will be offered in your country. Any reference to a licensed program in this publication is not intended to state or imply that you can use only the licensed program indicated. You can use any functionally equivalent program instead.

Documentation owner: Gary Hiemke

AIX is a registered trademark of International Business Machines Corporation.

Medeco is a trademark of Medeco Company.

©Copyright International Business Machines Corporation, 1996. All rights reserved.

Note to US Government Users – Documentation and programs related to restricted rights – Use, duplication, or disclosure is subject to the restrictions set forth in GSA ADP Schedule Contract.

---

# Table of Contents

<b>Communications Statements</b> .....	<b>v</b>
<b>Safety Notices</b> .....	<b>ix</b>
Power Cables and Plugs .....	xi
<b>About This Book</b> .....	<b>xiii</b>
<b>Chapter 1. System Unit Description</b> .....	<b>1-1</b>
Typical Workstation Arrangement .....	1-1
System Unit .....	1-1
System Unit Features .....	1-2
Disk Drives .....	1-4
Location Codes .....	1-5
Cover Removal .....	1-9
External Device Connectors .....	1-10
<b>Chapter 2. Using the System Unit</b> .....	<b>2-1</b>
Setting the Key Mode Switch .....	2-2
Starting the System Unit .....	2-4
Stopping the System Unit .....	2-4
Operating with Multiple Attached Systems .....	2-5
Power Control Capabilities .....	2-6
Reading the Three-Digit Display .....	2-7
Using the Reset Button .....	2-8
Using the Keyboards .....	2-9
Using the Three-Button Mouse .....	2-10
Using the 3.5-Inch Diskette Drive .....	2-13
Using the CD-ROM Drives .....	2-17
General Information for 2.3 and 5.0GB 8-mm Tape Drives .....	2-21
Using the 2.3GB 8-mm Tape Drive .....	2-24
Using the 5.0GB 8-mm Tape Drive .....	2-27
General Information for 4.0GB 4-mm Tape Drive .....	2-32
Using the 4.0GB 4-mm Tape Drive .....	2-36
Using the 1/4-inch Tape Drive .....	2-41
<b>Chapter 3. Using the Diagnostics</b> .....	<b>3-1</b>
Sources for the Diagnostic Programs .....	3-1
Diagnostic Programs Operating Considerations .....	3-1
Diagnostic Modes of Operation .....	3-10
Reading Flashing 888 Numbers .....	3-14

<b>Chapter 4. Using the Service Aids</b> .....	<b>4-1</b>
Introduction to Service Aids .....	4-1
Service Hints .....	4-1
Display Previous Diagnostic Results .....	4-2
Display or Change Configuration or Vital Product Data (VPD) .....	4-2
Display or Change Diagnostic Test List .....	4-3
Disk Media .....	4-3
Diskette Media .....	4-4
Local Area Network .....	4-4
SCSI Bus .....	4-4
Display Test Patterns .....	4-4
Microcode Download .....	4-4
Product Topology .....	4-5
Display/Alter Bootlist .....	4-9
Trace .....	4-9
Dials and LPFK Configuration .....	4-9
Diagnostic Diskette Creation .....	4-9
Disk-Based Diagnostic Update .....	4-9
Hardware Error Report .....	4-10
Display Test Patterns for the Multimedia Video Capture Adapter .....	4-10
 <b>Chapter 5. Using the System Verification Procedure</b> .....	 <b>5-1</b>
 <b>Chapter 6. Hardware Problem Determination</b> .....	 <b>6-1</b>
 <b>Chapter 7. Moving the System Unit</b> .....	 <b>7-1</b>
 <b>Appendix A: Supplies</b> .....	 <b>A-1</b>
Ordering Keys .....	A-2
Key Reorder Form .....	A-3
 <b>Appendix B. Three-Digit Display Numbers</b> .....	 <b>B-1</b>
Built-In Self-Test (BIST) Indicators .....	B-1
Power-On Self-Test (POST) Indicators .....	B-2
Dump Progress Indicators .....	B-11
Diagnostic Load Progress Indicators .....	B-12
Debugger Progress Indicators .....	B-13
Flashing 888 Message Descriptions .....	B-13
Type 102 Message .....	B-13
Type 103 and 105 Messages .....	B-14
 <b>Index</b> .....	 <b>X-1</b>

---

# Communications Statements

The following statement applies to this product. The statement for other products intended for use with this product appears in their accompanying manuals.

## Federal Communications Commission (FCC) Statement

**Note:** This equipment has been tested and found to comply with the limits for a Class A digital device, pursuant to Part 15 of the FCC Rules. These limits are designed to provide reasonable protection against harmful interference when the equipment is operated in a commercial environment. This equipment generates, uses, and can radiate radio frequency energy and, if not installed and used in accordance with the instruction manual, may cause harmful interference to radio communications. Operation of this equipment in a residential area is likely to cause harmful interference in which case the user will be required to correct the interference at his own expense.

Properly shielded and grounded cables and connectors must be used in order to meet FCC emission limits. Neither the provider nor the manufacturer are responsible for any radio or television interference caused by using other than recommended cables and connectors or by unauthorized changes or modifications to this equipment. Unauthorized changes or modifications could void the user's authority to operate the equipment.

This device complies with Part 15 of the FCC Rules. Operation is subject to the following two conditions: (1) this device may not cause harmful interference, and (2) this device must accept any interference received, including interference that may cause undesired operation.

## United Kingdom Telecommunications Safety Requirements

This equipment is manufactured to the International Safety Standard EN60950 and as such is approved in the UK under the General Approval Number NS/G/1234/J/100003 for indirect connection to the public telecommunication network.

The network adapter interfaces housed within this equipment are approved separately, each one having its own independent approval number. These interface adapters, supplied by the manufacturer, do not use or contain excessive voltages. An excessive voltage is one which exceeds 70.7 V peak ac or 120 V dc. They interface with this equipment using Safe Extra Low Voltages only. In order to maintain the separate (independent) approval of the manufacturer's adapters, it is essential that other optional cards, not supplied by the manufacturer, do not use main voltages or any other excessive voltages. Seek advice from a competent engineer before installing other adapters not supplied by the manufacturer.

## Avis de conformité aux normes du ministère des Communications du Canada

Cet appareil numérique de la classe A respecte toutes les exigences du Règlement sur le matériel brouilleur du Canada.

## Canadian Department of Communications Compliance Statement

This Class A digital apparatus meets the requirements of the Canadian Interference-Causing Equipment Regulations.

## International Electrotechnical Commission (IEC) Statement

This product has been designed and built to comply with IEC Standard 950.

## European Union (EU) Statement

This product is in conformity with the protection requirements of EU Council Directive 89/336/EEC on the approximation of the laws of the Member States relating to electromagnetic compatibility.

Neither the provider nor the manufacturer can accept responsibility for any failure to satisfy the protection requirements resulting from a non-recommended modification of the product, including the fitting of option cards not supplied by the manufacturer.

This product has been tested and found to comply with the limits for Class A Information Technology Equipment according to CISPR 22 / European Standard EN 55022. The limits for Class A equipment were derived for commercial and industrial environments to provide reasonable protection against interference with licensed communication equipment.

**Attention:** This is a Class A product. In a domestic environment this product may cause radio interference in which case the user may be required to take adequate measures.

## 電波障害自主規制 届出装置の記述

この装置は、第一種情報装置（商工業地域において使用されるべき情報装置）で商工業地域での電波障害防止を目的とした情報処理装置等電波障害自主規制協議会（VCCI）基準に適合しております。

従って、住宅地域またはその隣接した地域で使用すると、ラジオ、テレビジョン受信機等に受信障害を与えることがあります。

取扱説明書に従って正しい取り扱いをしてください。

## VCCI Statement

The following is a summary of the VCCI Japanese statement in the box above.

This equipment is in the Class 1 category (information equipment to be used in commercial and/or industrial areas) and conforms to the standards set by the Voluntary Control Council For Interference by Data Processing Equipment and Electronic Office Machines aimed at preventing radio interference in commercial and/or industrial areas.

Consequently, when used in a residential area or in an adjacent area thereto, radio interference may be caused to radios and TV receivers, etc.

Read the instructions for correct handling. VCCI-1.

## Radio Protection for Germany

Dieses Gerät ist berechtigt in Übereinstimmung mit dem deutschen EMVG vom 9.Nov.92 das EG-Konformitätszeichen zu führen.

Der Aussteller der Konformitätserklärung ist die IBM Germany.

Dieses Gerät erfüllt die Bedingungen der EN 55022 Klasse A. Für diese Klasse von Geräten gilt folgende Bestimmung nach dem EMVG:

Geräte dürfen an Orten, für die sie nicht ausreichend entstört sind, nur mit besonderer Genehmigung des Bundesministers für Post und Telekommunikation oder des Bundesamtes für Post und Telekommunikation betrieben werden. Die Genehmigung wird erteilt, wenn keine elektromagnetischen Störungen zu erwarten sind.

(Auszug aus dem EMVG vom 9.Nov.92, Para.3, Abs.4)

### Hinweis:

Dieses Genehmigungsverfahren ist von der Deutschen Bundespost noch nicht veröffentlicht worden.





---

# Safety Notices

**Note:** For a translation of these notices, see the *System Unit Safety Information*.

## Definitions of Safety Notices

A *danger* notice indicates the presence of a hazard that has the potential of causing death or serious personal injury. *Danger* notices appear on the following pages:

1-10  
7-1.

A *caution* notice indicates the presence of a hazard that has the potential of causing moderate or minor personal injury. A *caution* notice appears on the following page:

ix  
1-10  
2-17  
7-1.

## Lithium Battery

**Note:** For a translation of these notices, see *System Unit Safety Information*.

### **CAUTION:**

**A lithium battery can cause fire, explosion, or a severe burn. Do not recharge, disassemble, heat above 100°C (212°F), solder directly to the cell, incinerate, or expose cell contents to water. Keep away from children. Replace only with the part number specified for your system. Use of another battery may present a risk of fire or explosion.**

**The battery connector is polarized; do not attempt to reverse the polarity.**

**Dispose of the battery according to local regulations.**

---

## Laser Safety Information

**Note:** The Optical Link Card (OLC) referred to in this information is part of the Serial Optic Channel Converter assembly.

This system contains a laser product called the Optical Link Card (OLC). In the U.S., the OLC is certified as a Class 1 laser product that conforms to the requirements contained in the Department of Health and Human Services (DHHS) regulation 21 CFR Subchapter J. Internationally, the OLC is certified as a Class 1 laser product that conforms to the requirements contained in the International Electrotechnical Commission (IEC) standard 825 (1984), the Verband Deutscher Elektrotechniker (VDE) standard 0837 (1986), and the CENELEC (European Committee for Electrotechnical Standardization) Harmonization Document HD 482 S1 (1988). The German testing institute VDE assigned a certificate of conformity to DIN IEC 825/VDE 0837/02.86 and CENELEC HD 482 S1/03.88; the certificate registration number is 3642.

In addition, Statens Provningsanstalt (Swedish National Testing Institute) tested and approved the OLC for use in Sweden as a Class 1 laser product and assigned the approval number SP LA 89:184. The CDRH certification label and the VDE certificate of conformity mark are located on the plastic retainer of the OLC product. Figure 1 shows the system Class 1 information label required by IEC 825.

Class 1 laser products are not considered to be hazardous. The OLC internally contains a gallium aluminum arsenide (GaAlAs) semiconductor laser diode emitting in the wavelength range of 770 to 800 nanometers. This laser diode is a Class 3B laser that is rated at 5.0 milliwatts. The design of the OLC is such that access to laser radiation above a Class 1 level during operation, user maintenance, or service conditions is prevented.

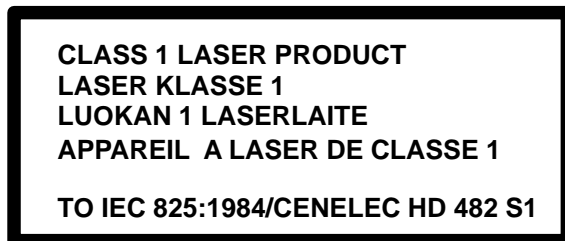
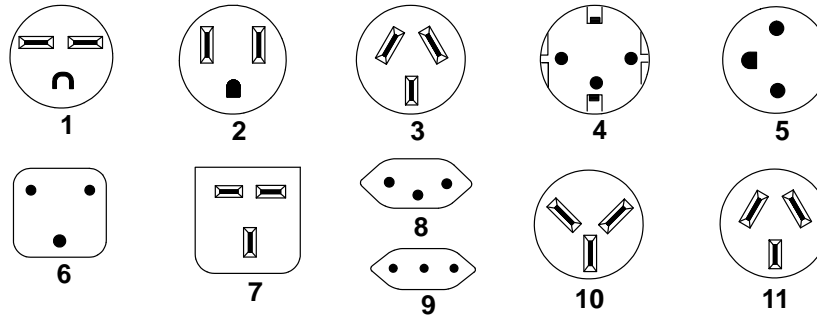

Figure 1. Class 1 System Information Label Required by the IEC 825 Standard

The Optical Link Card (OLC) must only be connected to another OLC or a compatible laser product. Any compatible laser product must contain the open fiber link detection and laser control safety system used in OLC. This is a requirement for correct operation of the optical link. In addition, the OLC product is designed and certified for use in applications with point-to-point optical links only. Using this product in any other type of optical link configuration (for example, links containing optical splitters or star couplers) is considered as not using the product correctly and may require that the user certify the laser product again for conformance to the laser safety regulations.

## Power Cables and Plugs



Index	Part Number	Country
1	1838574	Bahamas, Barbados, Bolivia, Brazil, Canada, Costa Rica, Dominican Republic, El Salvador, Ecuador, Guatemala, Guyana, Haiti, Honduras, Jamaica, Japan, Netherlands Antilles, Panama, Peru, Philippines, Taiwan, Thailand, Trinidad, Tobago, U.S.A. (except Chicago), Venezuela
2	6952300	Bahamas, Barbados, Bermuda, Bolivia, Brazil, Canada, Cayman Islands, Colombia, Costa Rica, Dominican Republic, Ecuador, El Salvador, Guatemala, Guyana, Haiti, Honduras, Jamaica, Japan, Korea (South), Mexico, Netherlands Antilles, Nicaragua, Panama, Peru, Philippines, Puerto Rico, Saudi Arabia, Suriname, Trinidad, Taiwan, U.S.A. (except Chicago), Venezuela
2	6952301	Chicago, U.S.A.
3	6952311	Argentina, Australia, New Zealand,
4	13F9979	Abu Dhabi, Austria, Belgium, Bulgaria, Botswana, Egypt, Finland, France, Germany, Greece, Iceland, Indonesia, Korea (South), Lebanon, Luxembourg, Macau, Netherlands, Norway, Portugal, Saudi Arabia, Spain, Sudan, Sweden, Turkey, Yugoslavia. Bosnia-Herzegovina, Croatia, Slovenia
5	13F9997	Denmark
6	14F0015	Bangladesh, Burma, Pakistan, South Africa, Sri Lanka
7	14F0033	Bahrain, Bermuda, Brunei, Channel Islands, Cyprus, Ghana, Hong Kong, India, Iraq, Ireland, Jordan, Kenya, Kuwait, Malawi, Malaysia, Nigeria, Oman, People's Republic of China, Qatar, Sierra Leone, Singapore, Tanzania, Uganda, United Arab Emirates (Dubai), United Kingdom, Zambia
8	14F0051	Liechtenstein, Switzerland
9	14F0069	Chile, Ethiopia, Italy
10	14F0087	Israel
11	6952291	Paraguay, Colombia, Uruguay



---

## About This Book

This book uses three-digit model numbers. You may, however, have other documentation that uses four-digit numbers. For example, the model 53H in this book may be referred to as a model 530H in other documentation. Both of these model numbers refer to the same system unit.

### ISO 9000

ISO 9000 registered quality systems were used in the development and manufacturing of this product.

### How to Use This Book

This book provides information about the operator controls and the devices installed in the 7013 system unit.

Chapter 6 contains the hardware problem determination guide.

### Related Publications

The *Problem Solving Guide and Reference* for your AIX operating system, order number SC23-2606, is the first book you should use when you have a problem with the system unit. It contains the procedure for determining if the problem is hardware or software related.

If the problem is software related, use the *Problem Solving Guide and Reference* for your AIX operating system.

The *Site and Hardware Planning Information* publication, order number SA38-0508, contains information about various hardware and software offerings and options for the system unit.

*System Unit Safety Information*, order number SA23-2652, contains translated versions of the danger and caution notices.



---

## Chapter 1. System Unit Description

This chapter contains information to help you become familiar with the 7013 system unit.

---

### Typical Workstation Arrangement

Your system unit can have a display, keyboard, and mouse attached to it, plus a wide range of other available options, such as a tape drive, printers, data communications, terminals, and plotters.

The following illustration shows a typical office arrangement using the 7013 system unit.

**Attention:** Damage can result if the system unit is placed closer than three inches to a wall or desk.

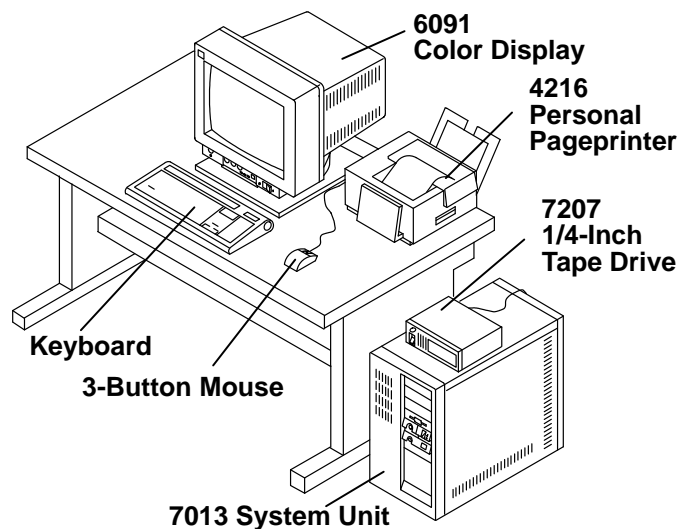

---

### System Unit

The system unit contains a 32-bit processor, input and output adapters, memory, and media storage devices. The hardware is controlled by the operating system.

Additional memory cards can be added to the standard memory size of each model of the system. For more information, refer to the *Site and Hardware Planning Information*, order number SA38-0508.

The system unit provides a slot for an optional Serial Optical Channel Converter (Models 58H, 590, 59H, 591, and 595 do not support the optional Serial Optical Channel Converter), and eight slots for the installation of Micro Channel adapters. On early system units, one Small Computer Systems Interface (SCSI) adapter or a SCSI-2 adapter are standard. On the Models 55L, 570, 580, 58H, 590, 59H, 591, and 595 the SCSI is integrated into the I/O planar. Internal hardware controls the 3.5-inch diskette drive, speaker, two serial ports, one parallel port, mouse, keyboard, tablet, and disk drives.

The operator panel is accessible from the front of the system unit. Attached device cables enter the back of the system unit through the cable guide.

# System Unit Features

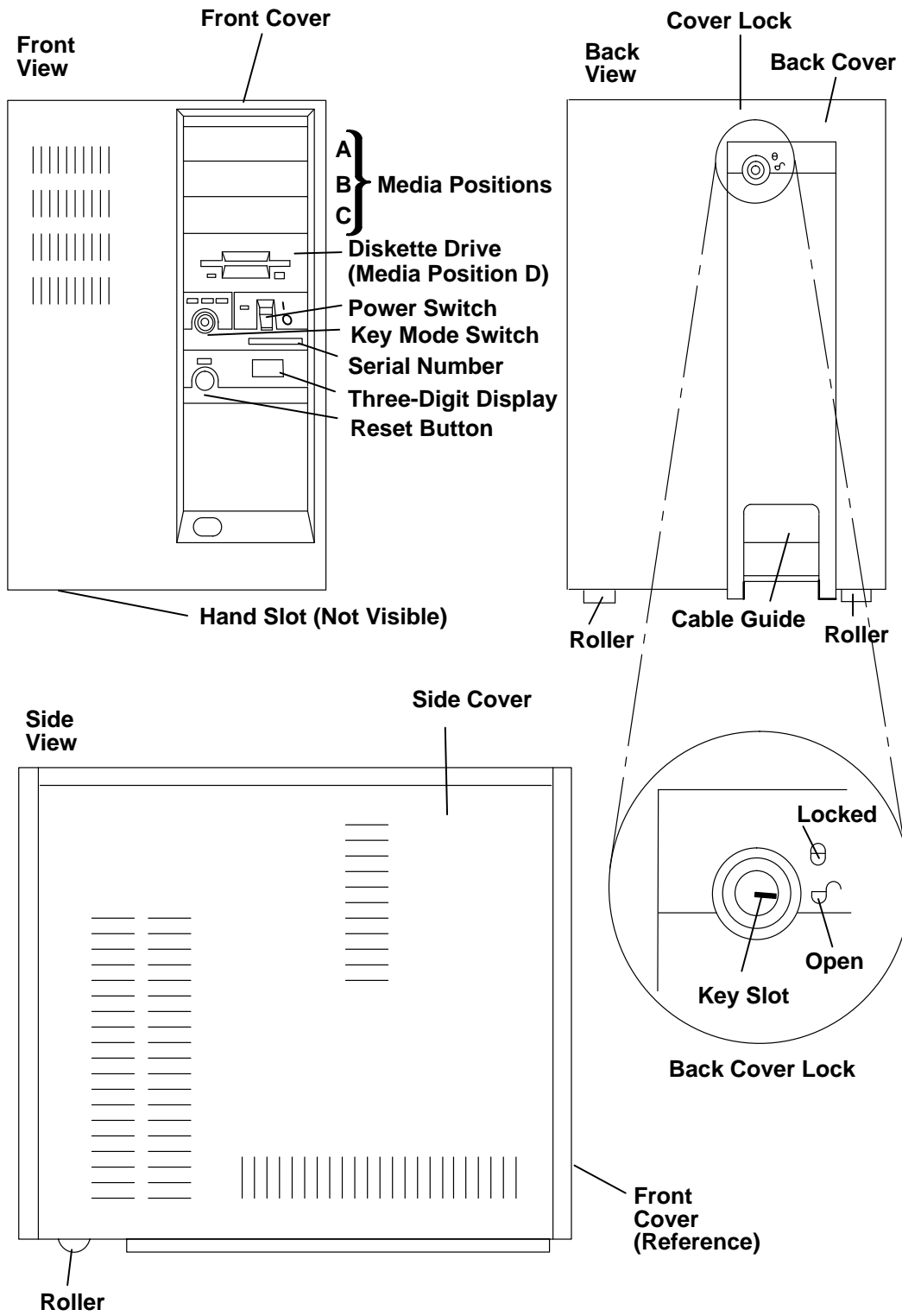



<b>Front Cover</b>	Provides access to the operator panel, 3.5-inch diskette drive, and any drives in the three media positions.
<b>Media Positions</b>	Includes two or three half-height positions (A, B, and C) that are provided for installing half-height or full-height devices. These options can be added at any time. Some models have a CD-ROM standard in media position C.
<b>Diskette Drive</b>	Contains a standard 1.44MB, 3.5-inch diskette drive in media position D.
<b>Power Switch</b>	Has the international symbols (I) for On and (O) for Off. The power switch has a power-on light.
<b>Serial Number</b>	Is located below the power switch, and on the back panel under the back cover.
<b>Key Mode Switch</b>	Is a key-controlled switch with three positions labeled: <ul style="list-style-type: none"> <li>• Normal</li> <li>• Secure</li> <li>• Service.</li> </ul>
<b>Three-Digit Display</b>	Displays up to three characters.
<b>Attention:</b> Pressing the Reset button with the mode switch in the Normal or Service position and the operating system running can result in damaged or lost data.	
<b>Reset Button</b>	Is located next to the three-digit display and is labeled Reset.
<b>Hand Slot</b>	Is located on the bottom center of the front cover and can be used to raise the front of the system unit when positioning it.
<b>Back Cover</b>	Is removable and provides access to the system unit connectors.
<b>Cover Lock</b>	Is located on the back cover, and provides physical security (when locked) by preventing removal of any cover. The key-controlled mode switch and cover lock use the same key. The cover lock is locked when the key slot points to the locked symbol and is unlocked when the key slot is turned clockwise to the open symbol.
<b>Rollers</b>	Are located on the bottom of the system unit, and assist in positioning the unit.
<b>Cable Guide</b>	Allows orderly arrangement of the cables.
<b>Side Covers</b>	Are removable and allow access inside the unit. <i>Only trained service technicians should work on parts that are inside the system unit.</i>

## Disk Drives

The system unit has disk drive positions inside the system unit. There are no operator controls on these internal disk drives.

Sometimes data is lost because of user action, accident, or equipment trouble, so you should back up disk data at regular intervals. See your operating system documentation for information about using diskettes or tape drives to back up files.

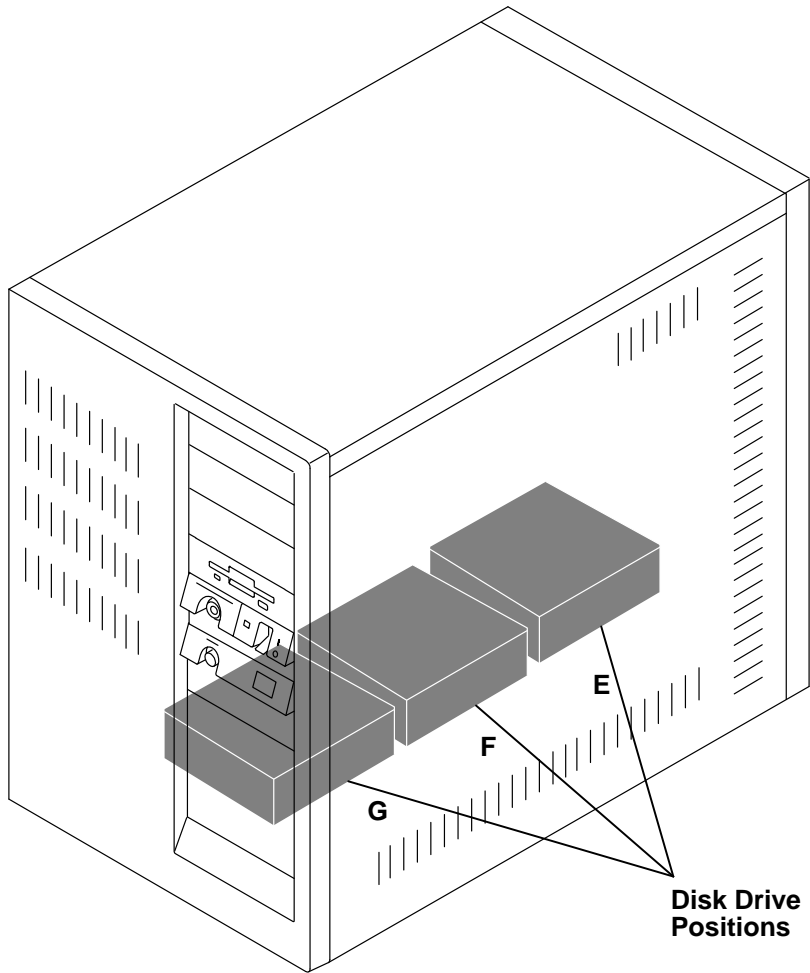

---

## Location Codes

A location code is used to physically locate a failing device or unit. The location code is displayed along with the service request number (SRN) when the diagnostic programs isolate a failure. If the location code is not known, you can run the Display Previous Diagnostic Results service aid to display the results of the last time the diagnostic programs were run.

When you know the location code, refer to the table on page 1-7 to determine the physical location of the device.

**Note:** An attached SCSI device is identified by its SCSI address setting, not a physical location. The SCSI device may be labeled with its SCSI address number.

### Location Code Format for 7135, 9333 and 9334 Devices

The location code formats for the 7135, 9333, and 9334 devices are described in the publications for the 7135, 9333, and 9334.

### Location Code Format for Non-SCSI Devices

The following example is for non-SCSI devices. These include planars, memory cards, adapters, and async distribution boxes.

Use the example to determine the physical location of a device.

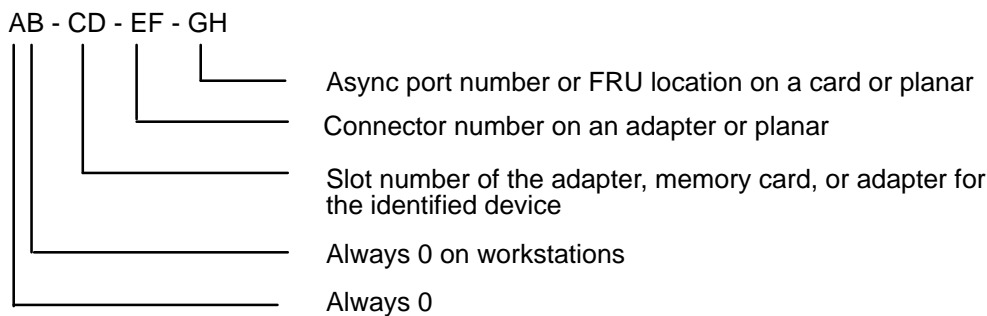

### Location Code Format for 128-Port Async Subsystems

Use this example to determine the physical location of 128-port Async Controllers and associated 16-Port Remote Async Nodes

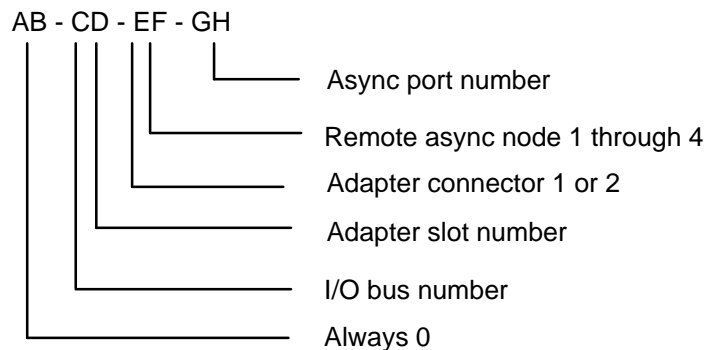

## Location Code Format for SCSI Devices

Use Appendix A to determine the physical location of a SCSI device.

AB - CD - EF - GH

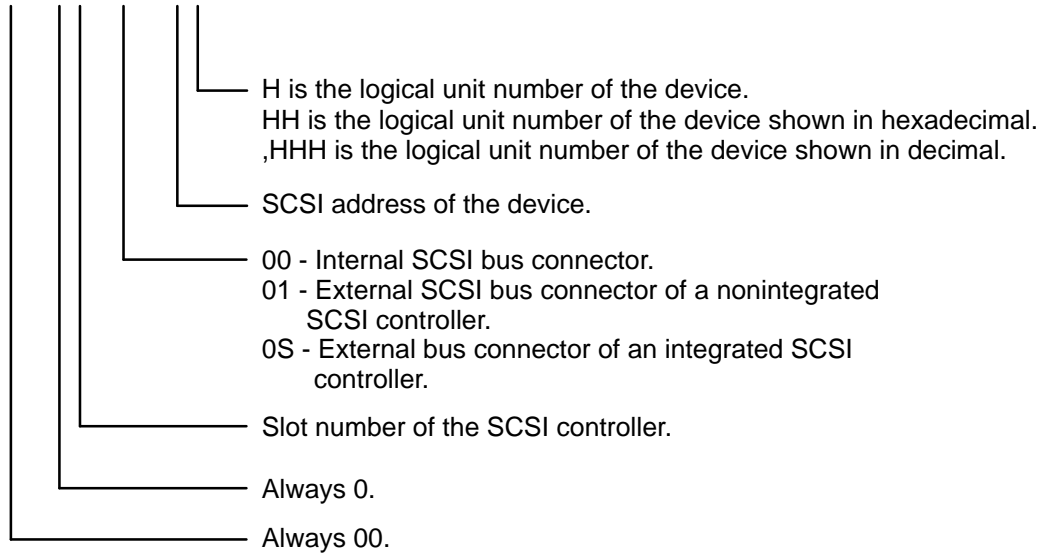

## Location Code Table

Use the following table to determine the physical location of a device or unit.

**Note:** The location code format for 9333 and 9334 devices is described in the documentation for these devices.

Use the following example to identify the two-character pairs:

AB-CD-EF-GH

Pair	Value	Description
AB	00	Workstation-type system unit
CD	00	CPU planar
	00	Standard I/O planar
	00	A device attached to the standard I/O planar
	01	Adapter in slot 1 of the I/O planar
	02	Adapter in slot 2 of the I/O planar
	03	Adapter in slot 3 of the I/O planar
	04	Adapter in slot 4 of the I/O planar
	05	Adapter in slot 5 of the I/O planar
	06	Adapter in slot 6 of the I/O planar
	07	Adapter in slot 7 of the I/O planar
	08	Adapter in slot 8 of the I/O planar
	0A	Memory card in slot A on the CPU planar
	0B	Memory card in slot B on the CPU planar
	0C	Memory card in slot C on the CPU planar
	0D	Memory card in slot D on the CPU planar
0E	Memory card in slot E on the CPU planar	
0F	Memory card in slot F on the CPU planar	
0G	Memory card in slot G on the CPU planar	
0H	Memory card in slot H on the CPU planar	
0J		TCW SIMM socket
	0K	TCW SIMM socket
AA		Serial Optic Converter in slot AA of CPU planar

Pair	Value	Description
EF	00	Does not have a connector or software was not able to identify the connector number.
	01 02 03 04	The number of the connector on an adapter card, distribution box, or planar
	0D	Internal diskette connector on the standard I/O planar
	0E	Built-in Ethernet adapter
	0K	Keyboard connector on the standard I/O planar
	0M	Mouse connector on the standard I/O planar
	0P	Parallel printer connector on the standard I/O planar
	0S	Built-in SCSI adapter
	0T	Tablet connector on the standard I/O planar
	S1 S2	Serial port 1 connector on the standard I/O planar Serial port 2 connector on the standard I/O planar
1A 1B	Port A of the Serial Optic Converter in slot AA of the CPU planar Port B of the Serial Optic Converter in slot AA of the CPU planar	
GH or GHH or G,HHH	00	For devices other than those listed here
	00 thru 15	Port addresses for 8-port async, 16-port async, and 16-port concentrator distribution boxes
	01	Diskette drive 1
	01 02 03 04 05 06 07 08	Memory SIMM in location 1 on the memory card. Memory SIMM in location 2 on the memory card. Memory SIMM in location 3 on the memory card. Memory SIMM in location 4 on the memory card. Memory SIMM in location 5 on the memory card. Memory SIMM in location 6 on the memory card. Memory SIMM in location 7 on the memory card. Memory SIMM in location 8 on the memory card.
	00 thru FF	SCSI address and logical unit number of the device
	000 thru FFF	SCSI address and logical unit number of the device shown in hexadecimal
	0,000 thru F,255	SCSI address and logical unit number of the device shown in decimal <b>Note:</b> When a comma appears between the G and H, digits appearing to the right of the comma are represented in decimal.
	<b>Note:</b> See Appendix A to determine physical location.	

---

## Cover Removal

### Removal

1. Set the power switches on the attached devices to Off.
2. Set the power switch on the system unit to Off.
3. Use either of your two identical keys to unlock the back cover.

**Attention:** Do not operate the system unit with the cover removed. Operating with the cover on ensures adequate cooling of the components.

4. Pull the back cover out at the top and rotate it down, and then lift the cover up and out of the bottom of the system.

**Back Cover Keylock**

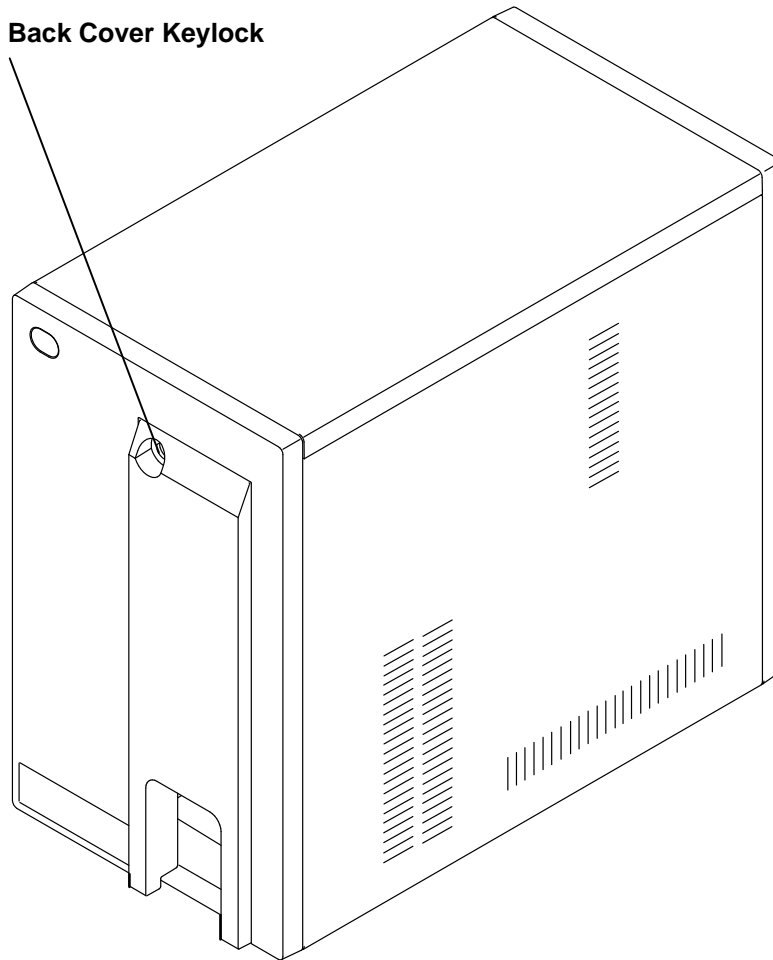

## External Device Connectors

**Note:** For a translation of these notices, see the *System Unit Safety Information*.

### DANGER

An electrical outlet that is not correctly wired could place hazardous voltage on metal parts of the system or the devices that attach to the system. It is the responsibility of the customer to ensure that the outlet is correctly wired and grounded to prevent an electrical shock.

Before installing or removing signal cables, ensure that the power cables for the system unit and all attached devices are unplugged.

When adding or removing any additional devices to or from the system, ensure that the power cables for those devices are unplugged before the signal cables are connected. If possible, disconnect all power cables from the existing system before you add a device.

Use one hand, when possible, to connect or disconnect signal cables to prevent a possible shock from touching two surfaces with different electrical potentials.

During an electrical storm, do not connect cables for display stations, printers, telephones, or station protectors for communications lines.

### CAUTION:

This product is equipped with a 3-wire power cable and plug for the user's safety. Use this power cable in conjunction with a properly grounded electrical outlet to avoid electrical shock.

When the back cover is removed, the system unit connectors and ports are accessible. These connectors and ports, shown in the following illustrations, are used to attach external devices.

#### Model 595

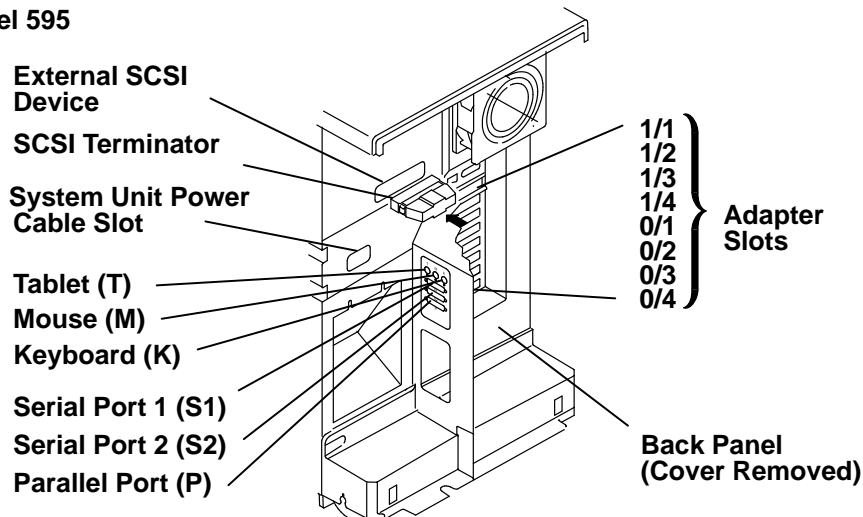



**Models 570, 580, 58H, 590, 59H, 591**

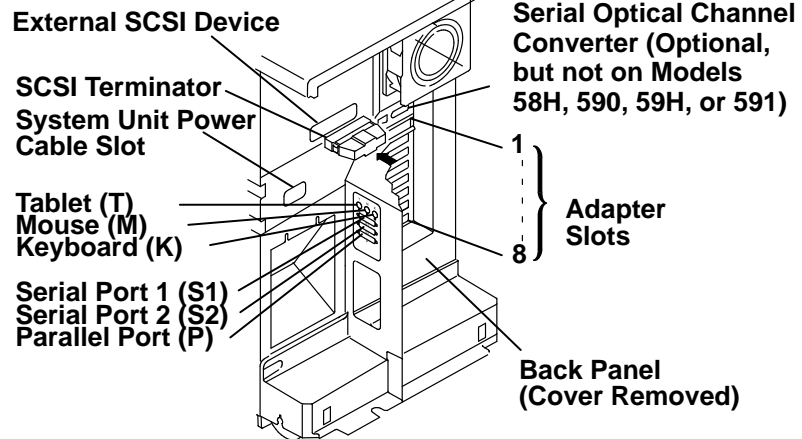

**Model 55L**

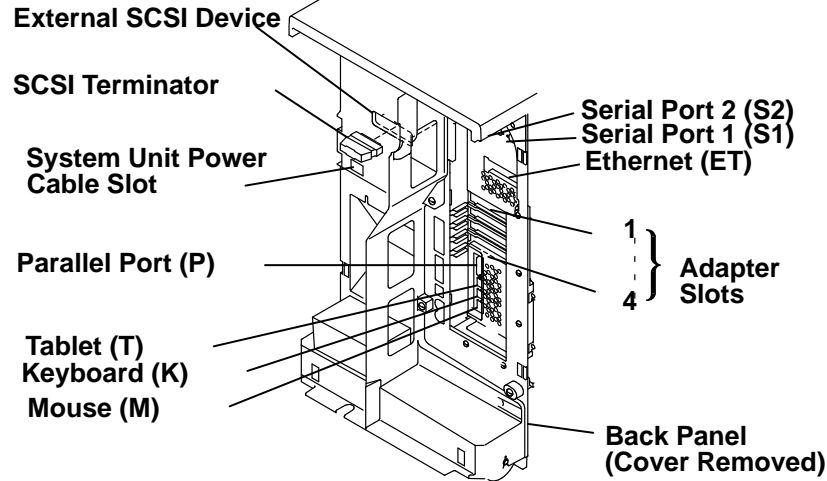

**Early Models**

**5.25-Inch External Diskette Drive (Optional)**

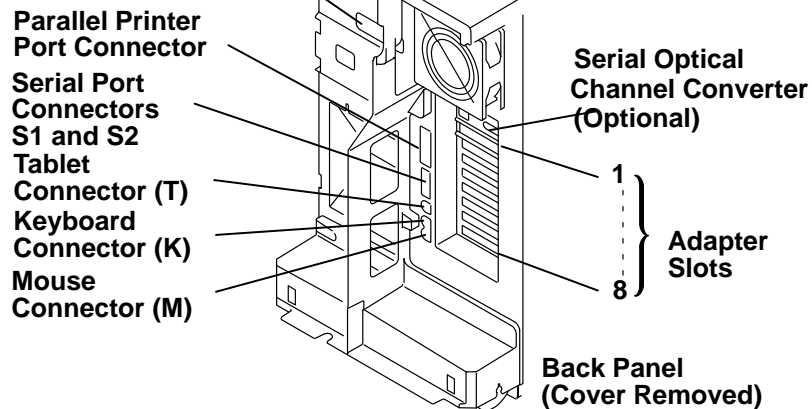



---

## Chapter 2. Using the System Unit

This chapter explains how to use the operator panel and other devices for control, input, display, and data storage in the 7013 system unit.

**Attention:** Model 55L is shipped with four foam retainers inside the left cover. Two of these retainers must be removed before you turn on the system power.

### Model 55L

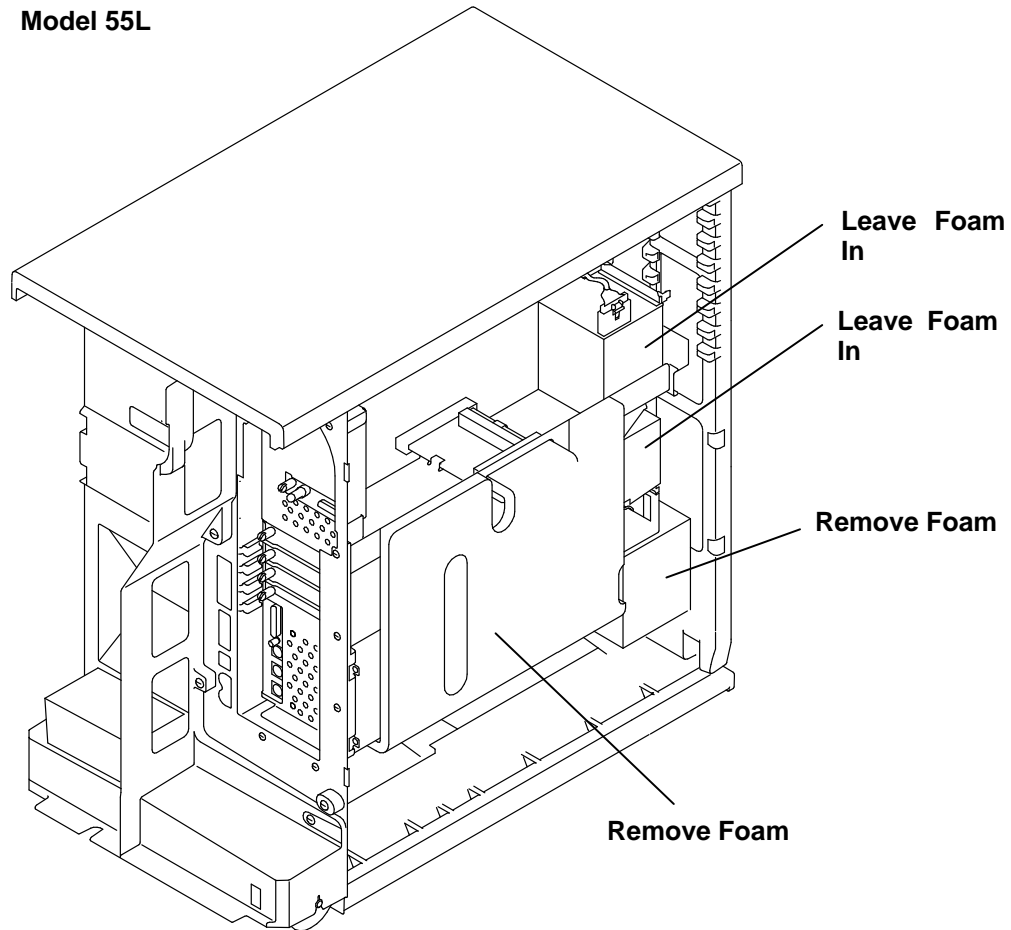

## Setting the Key Mode Switch

The key mode switch has three positions:

- Normal
- Secure
- Service.

The switch is used to establish the initial program load (IPL) path. The IPL loads the system programs, checks the system hardware, and prepares the system for user operation.

**Note:** If you start a Model 570, 580, 58H, 590, 59H, 591, or 595 system with the key mode switch in the Secure position, the power-on light does not come on and the three-digit display remains blank.

Before starting the system unit for normal day-to-day operation, set the key mode switch to the Normal position. This permits the operating system to load after the power-on self-tests (POSTs) are completed.

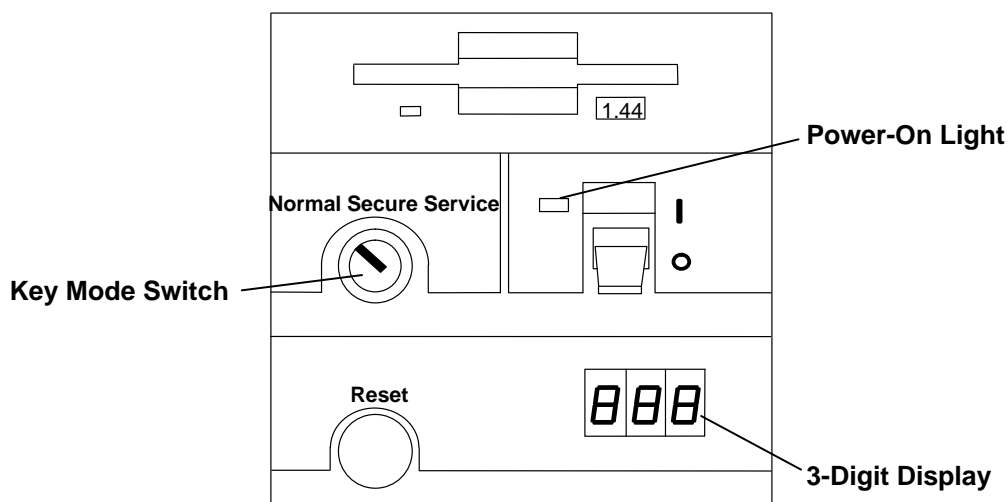

The following table summarizes the operations possible for each key mode switch position:

Operation	Key Mode Switch Position		
	Normal	Secure	Service
Reset	Yes	No	Yes
Keyboard Active	Yes	Yes	Yes
Keyboard Debug/Dump	No	No	Yes
Normal IPL	Yes	No	No
Service IPL	No	No	Yes

The following list explains the uses of the key mode switch positions:

- The Normal position is used for attended operation, which is the usual or normal placement of the key mode switch when an operator is present and in control of the operation at the system unit. The Reset button is active when the key mode switch is in the Normal position. The IPL proceeds according to the list of devices established during configuration of the operating system.

**Note:** If an operating system (software) is not installed, use the Service position for initial installation (from diskettes).

**Attention:** Pressing the Reset button when the key mode switch is in the Normal or Service position can cause data to be damaged or lost if the operating system is still running. For additional information on the Reset button operation, refer to the *Problem Solving Guide and Reference*.

- The Secure position is used for unattended operation in an open environment. For example, the system unit could be used for process control in a manufacturing area where an operator, responsible for the system operation, is not located in the immediate area.

In the Secure position, the Reset button is not active. The Secure position prevents any IPL from completing. With the key mode switch in this position, a passerby cannot accidentally press the Reset button and cause a loss of data.

**Notes:**

1. For early system units, if you start the system with the key mode switch in the Secure position, the system unit IPL stops, and the three-digit display shows the number 200. If you start a Model 570, 580, 58H, 590, 59H, 591, or 595 system with the key mode switch in the Secure position, the power-on light does not come on and the three-digit display remains blank. The system does not perform any further operations until the key mode switch is set to the Normal or Service position.
  2. When the key mode switch is moved to the Secure position after the IPL, all system functions continue to operate to allow data entry and retrieval.
- The Service position is used for attended operation when hardware or software service is conducted. The Service position activates operating system keyboard sequences that support error determination (debug) and storage printout (dump). In the Service position, the system unit attempts to perform an IPL from the diskette drive or CD-ROM. If there is no diskette in the drive or if there is no IPL record on the diskette, the system attempts to perform an IPL from a predetermined list of IPL devices.

**Attention:** The Reset button is active when the key mode switch is in the Normal or Service position, and pressing the Reset button can cause data to be damaged or lost if the operating system is still running.

If there is a problem with the system unit, refer to the *Problem Solving Guide and Reference* before setting the key mode switch in the Service position or pressing the Reset button.

---

## Starting the System Unit

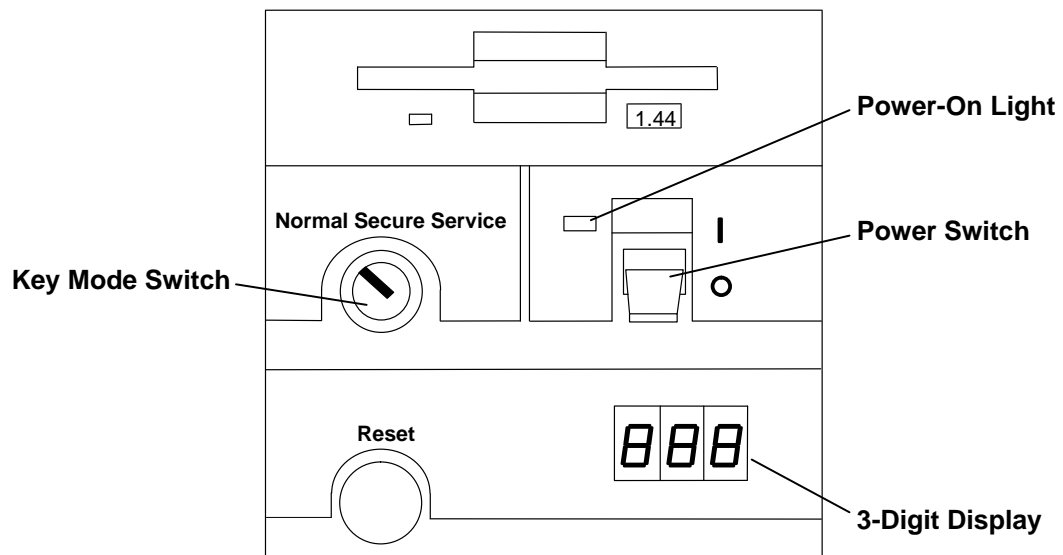

1. Set the key mode switch to the Normal position.
2. Set the power switches of the attached devices to On.
3. Start the system unit by setting the power switch to On (I).
4. If power does not come on when you set the power switch to On, ensure that the power cord, located at the back of the system unit, is plugged into a grounded electrical wall outlet. If this does not solve the problem, refer to the *Problem Solving Guide and Reference*.

When you set the power switch to On, the power-on light comes on and the system starts an internal power-on self-test (POST).

During the POST, numbers are displayed in the three-digit display.

---

## Stopping the System Unit

**Attention:** When using the **shutdown** procedure for your system, enter the correct command. If you do not do this, you can lose data. If you need information on the **shutdown** procedure, refer to your operating system documentation.

1. Before stopping the system unit, you must first do a **shutdown** procedure to prevent the loss of data.
2. After you shut down the operating system, set the power switches of the attached devices to Off.
3. Stop the system unit by setting the power switch to Off.
4. Set the key mode switch to the Secure position and remove the key.

---

## Operating with Multiple Attached Systems

When you are operating a system that is attached to one or more other systems, consider how actions you take with your system can affect the attached systems, and how other systems can affect yours. Consult with the operator of an attached system whenever you think your operations might affect each other.

The following actions can affect or be affected by the operation of an attached system:

- Starting and stopping communication with the other system
- Running diagnostics on the system
- Using wrap plugs with diagnostic programs
- Analyzing error log information.

Isolate a system unit from any attached systems before stopping the operating system or running diagnostic programs. Some system cabling changes (such as installing wrap plugs or removing a device from the configuration) may require action by the operator of the attached system before you make the cabling changes on your system.

---

## Power Control Capabilities

**Note:** If you start a Model 570, 580, 58H, 590, 59H, 591, or 595 system with the key mode switch in the Secure position, the power-on light does not come on and the three-digit display remains blank.

**Note:** If your system is a high-availability system, make sure all power control interface (PCI) cables are disconnected. High-availability systems usually require devices to remain powered on when the 7013 Model 570, 580, 58H, 590, 59H, 591, or 595 is powered off. If the power control to certain devices in your system is different from the factory settings, use your planning information and the following information to understand power control.

Models 570, 580, 58H, 590, 59H, 591, and 595 have power control capabilities. These include the following:

- Setting a time in the future for your machine to power off.
  - This is controlled by the **shutdown** command. For further information, see the *Commands Reference* for your operating system.
- Power control of optional attached devices.
  - The 7013 Models 570, 580, 58H, 590, 59H, 591, and 595 can be the source of the power control interface (PCI) signal that sets the status of power for all connected devices. When the power switch for the Model 570, 580, 58H, 590, 59H, 591, or 595 is set to On, a signal is sent to the main PCI (J210 and J211). Depending on the switch position, power is either set to On or Off for all devices controlled by the PCI signal. The PCI signal is connected to the devices by power control signal cables attached to the Main PCI connectors on the back of each device. The two main PCI connectors on the Model 570, 580, 58H, 590, 59H, 591, or 595 are output only; however, on some devices, one of the Main PCI connectors is common input and the remaining connector is an output that can supply the PCI signal to additional devices.

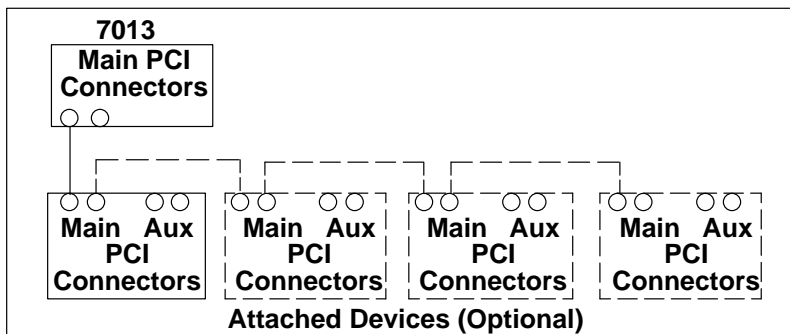

- Aux (auxiliary) PCI connectors are located on the back of some devices. Power to a device can be controlled by two different Model 570, 580, 58H, 590, 59H, 591, or 595s when the Main PCI connector on the device is connected to one Model 570, 580, 58H, 590, 59H, 591, or 595 and an Aux connector on the device is connected to the Main PCI connector of another Model 570, 580, 58H, 590, 59H, 591, or 595. When PCI cables are connected to a device in this way, the device receives power when either Model 570, 580, 58H, 590, 59H, 591, or 595 is on or when both Model 570, 580, 58H, 590, 59H, 591, or 595s are on. This configuration can be used to connect one or more devices that are shared by two system units, as shown in the following diagrams.



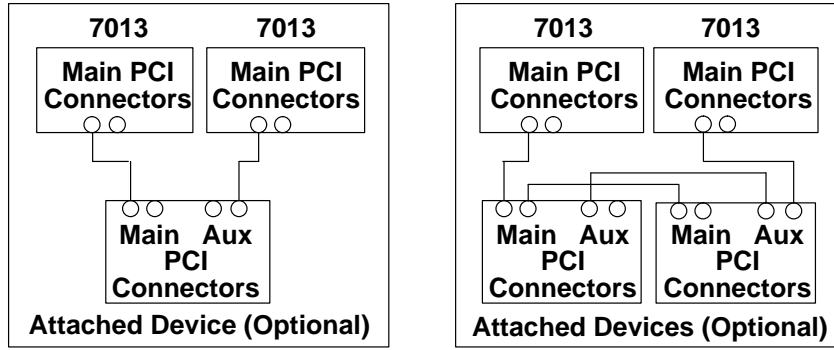

## Reading the Three-Digit Display

**Attention:** If you have a flashing 888 in the three-digit display, do not push the Reset button before you refer to the procedure in “Reading Flashing 888 Numbers” on page 3-14.

The three-digit display on the operator panel is used to:

- Track the progress of the system unit self-tests and configuration program.
- Display codes when the operating system comes to an abnormal end.
- Display diagnostic program messages when the display console is not working correctly.

During the POST, the numbers displayed indicate the progress of the testing. If an error is detected that requires attention, the system unit stops and a number is displayed in the three-digit display to identify the error.

When the self-tests complete without error, the display is blank.

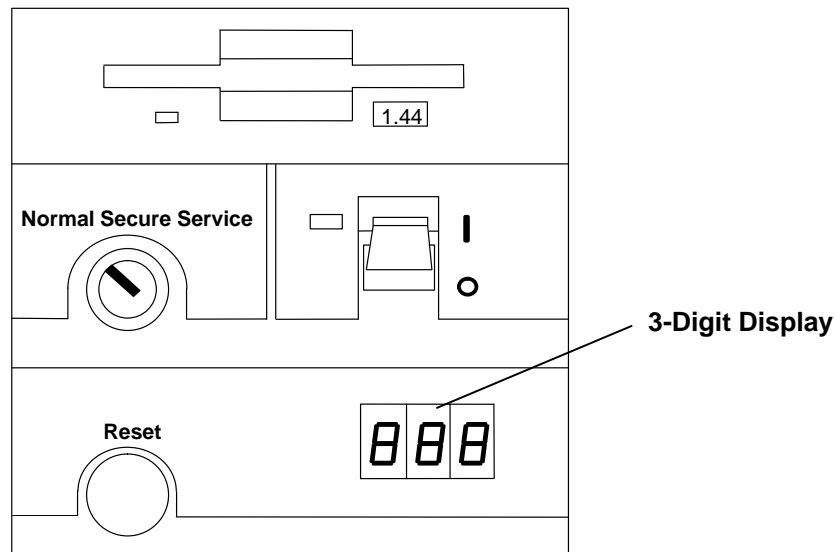

---

## Using the Reset Button

**Attention:** When the key mode switch is in the Normal or Service position, pressing the Reset button causes the unit to reset and perform an IPL. Pressing the Reset button while the operating system is running can result in damaged or lost data.

The Reset button has two purposes:

- To restart the system when the key mode switch is in the Normal or Service position.
- To read out codes or diagnostic messages after a flashing 888 is displayed in the three-digit display.

**Note:** Before pressing the Reset button in this situation, refer to the *Problem Solving Guide and Reference*.

When the key mode switch is in the Secure position, the Reset button is disabled and you cannot perform an IPL by pushing the Reset button.

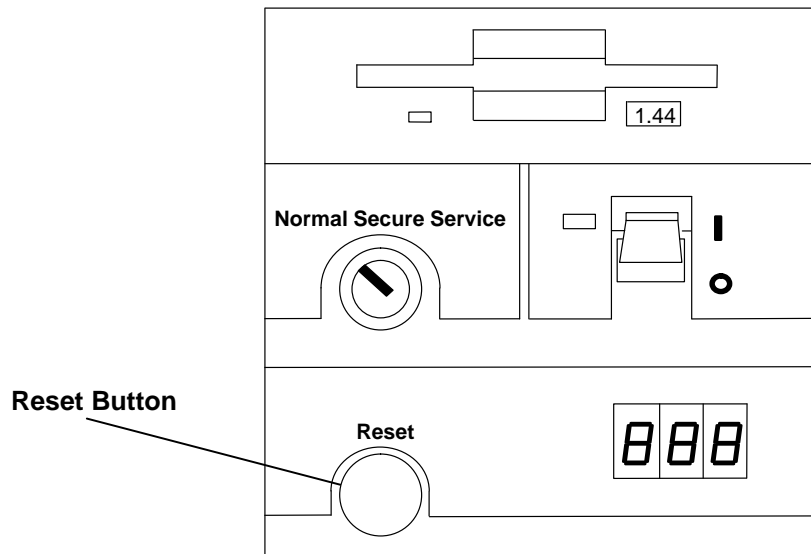

---

## Using the Keyboards

There are numerous keyboards available with the system unit. The various keys on the keyboard allow you to enter data and control the cursor location. The keys can be engraved for the languages of different countries.

The functions of each keyboard depend on the software used. Refer to your operating system documentation for more information.

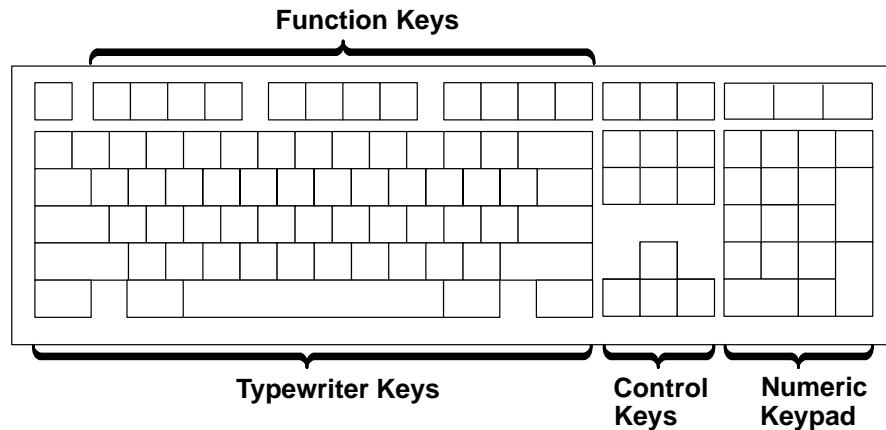

The keyboard is divided into four sections:

- The function keys are multipurpose keys; their functions are controlled by the operating system.
- The typewriter keys are similar to a standard typewriter; their functions are controlled by the software.
- The control keys move the cursor on the screen and do programmed control functions. The movement and functions depend upon the application program that you use.
- The numeric keypad is arranged like a calculator to help when typing numbers.

On all of the keyboards, you can adjust the tilt position for typing comfort. To tilt the keyboard, pull out on the keyboard legs. The legs snap into position. To decrease the tilt of the keyboard, rotate the keyboard legs until they snap into the bottom of the keyboard case.

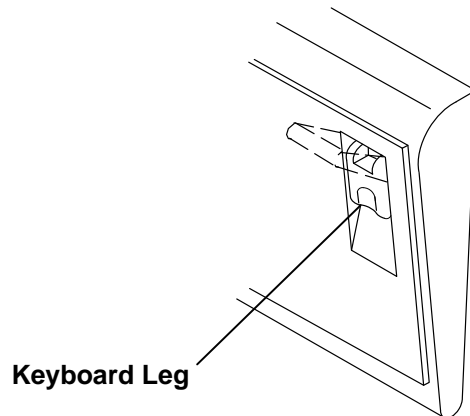

---

## Using the Three-Button Mouse

The mouse is a hand-operated locating device. A three-button mouse is available for use with the system unit.

Consult your application publication for the exact use of the three-button mouse.

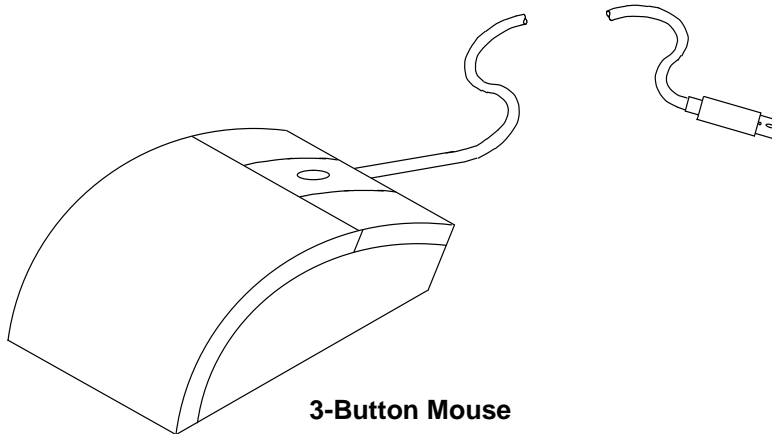

You can use the mouse to perform such functions as positioning a cursor and selecting items from a menu. The mouse allows you to move around quickly in your document. You can also use the mouse for graphics applications if the software is so equipped. The cursor, or image of the mouse on the screen, moves with the mouse as you move it on a desktop.

When you move the mouse around on a flat surface, the cursor moves in the same direction on the screen; the movement positions the cursor.

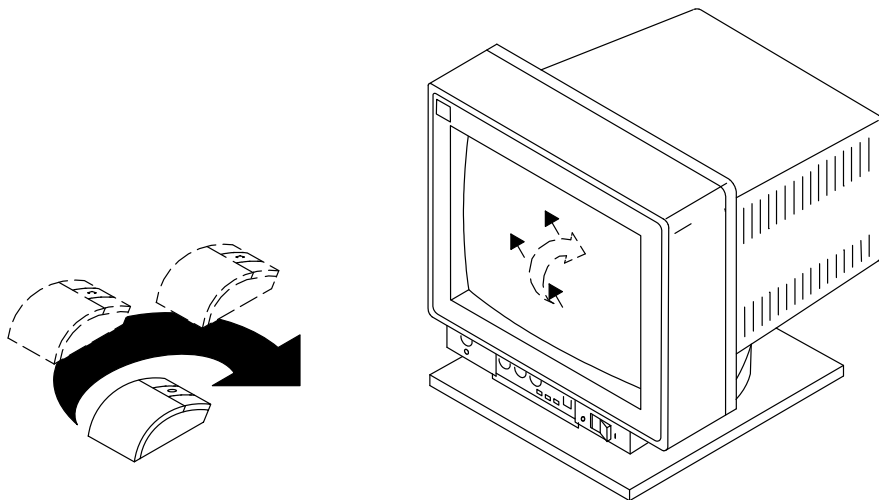

With the mouse buttons, you can perform functions such as selecting and deselecting options, extending your selection, or choosing a command. The precise function of your mouse depends on the software you are using.

The mouse has a cable that plugs into a mouse connector on the back of the system unit.

## Handling the Mouse Correctly

For best operation, observe the following precautions:

- Do not operate the mouse on cloth, unfinished wood, newspaper, or carpet.
- Do not drop or hit the mouse.
- Do not carry the mouse by holding onto the cable.
- Do not expose the mouse to extreme temperatures or direct sunlight.
- Do not place the mouse in liquid spills.

## Care of the Mouse

The operating surface for the mouse should be smooth, clean, and flat. For example, you can operate the mouse on the following surfaces:

- Finished wood
- Glass
- Enamel
- Plastic
- Paper (except newspaper)
- Metal.

Rough surfaces collect contaminants that can be transferred to the interior of the mouse by the ball. The surface you use should be free of spills, dirt, dust, lint, wax, eraser dust, and other foreign matter. Rough surfaces can also cause the pads located on the bottom of the mouse to wear prematurely. A deeply pitted surface could cause erratic operation of the mouse. In order to prevent this:

- Inspect the work surface for spills or other contaminants.
- Dust the work surface.

## Cleaning the Mouse

Use the following procedure when you clean the mouse:

1. Remove the retaining ring by turning the retaining ring counterclockwise, in the direction of the arrows.

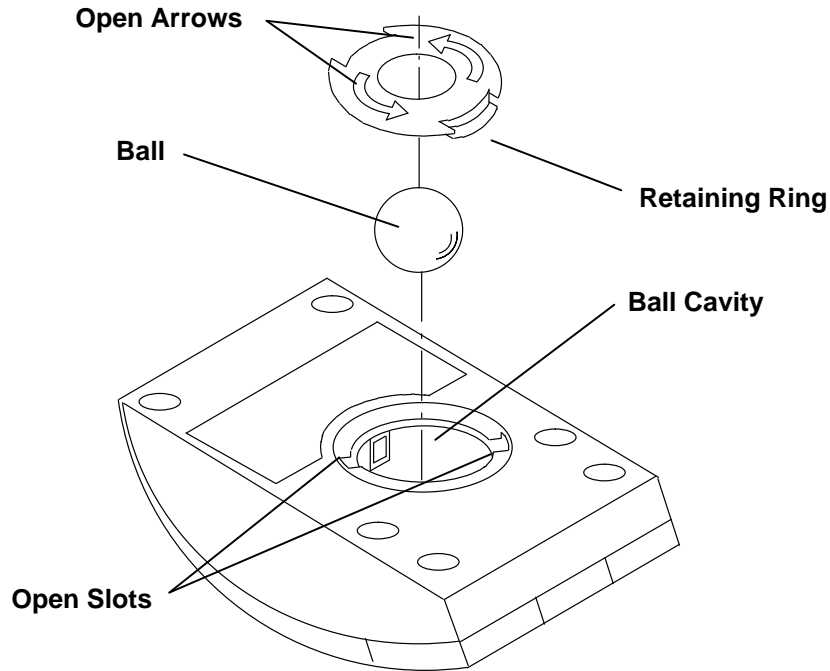

2. Remove the ball.
3. Inspect the ball for contaminants. Wipe it clean with a dry, lint-free cloth.
4. If the ball is dirty, wash it in warm, soapy water. Rinse and wipe the ball with a lint-free cloth until dry.
5. Inspect the ball cavity in the mouse for foreign materials. If there are any foreign materials, remove them.
6. Replace the ball.
7. Replace the retaining ring on the mouse and align it with the open slots in the ball cavity.
8. Turn the retaining ring clockwise until the open slots are covered and you hear the ring snap into place.

---

## Using the 3.5-Inch Diskette Drive

The in-use light is on when the system is accessing the drive. The number 1.44 is printed on the diskette-unload button.

Do not stop the system unit or remove a diskette when the in-use light is on, or you may lose some of the data on the diskette.

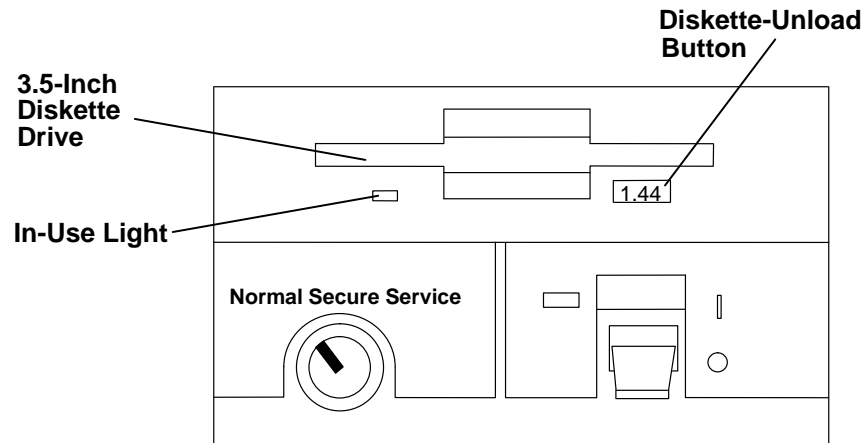

## Handling Your Diskettes

Be careful with your diskettes. Because each piece of information occupies such a small area on the diskette, small scratches, dust, food, or tobacco particles can make the information unusable. Be sure to remember the following:

- Do not touch the recording surfaces.
- Keep diskettes away from magnets and magnetic field sources such as telephones, dictation equipment, and electronic calculators.
- Keep diskettes away from extreme heat and cold. The recommended temperature range is 10°C to 60°C (50°F to 140°F).
- Proper care helps prevent loss of information.
- Make backup copies of your diskettes regularly.

## Types of 3.5-Inch Diskettes

**Attention:** Diskette drives and diskettes must be the correct type to store data successfully. If you use the wrong diskette in your 3.5-inch diskette drive, the data on the diskette could be destroyed.

The diskette drive uses the following 3.5-inch diskettes:

- 1.0MB capacity (stores approximately 720KBs of data)
- 2.0MB capacity (stores approximately 1.44MBs of data).

**A 1MB diskette looks like this:**

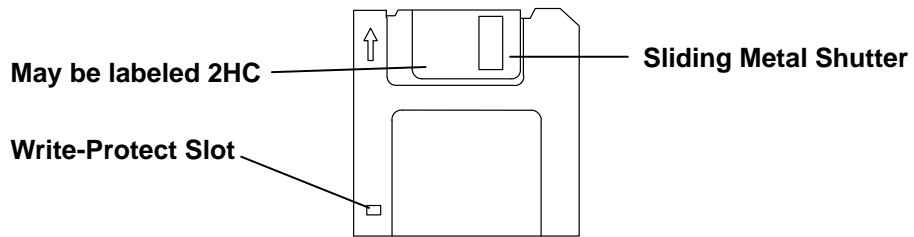

**A 2MB diskette looks like this:**

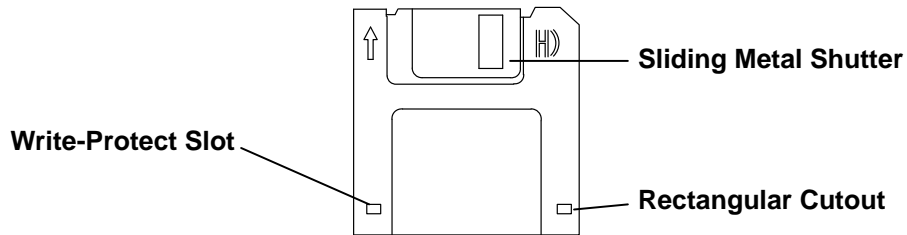

**Attention:** Some computers operate with 720KB diskette drives (no printing on the diskette-eject button) that use only 1.0MB capacity diskettes. If you are transferring work between computers with different diskette drives, be certain that the diskettes are compatible. For more information, refer to your operating system manual.



## Setting the Write-Protect Tab

Write-protecting diskettes is necessary to ensure that important information is not accidentally lost.

When diskettes are write-protected, you can read information from the diskettes, but you cannot write information on them.

There is a write-protect tab on the 3.5-inch diskette.

To locate the write-protect tab, turn the diskette over with the label facing down.

To prevent writing onto a diskette, slide the write-protect tab to open the protect slot.

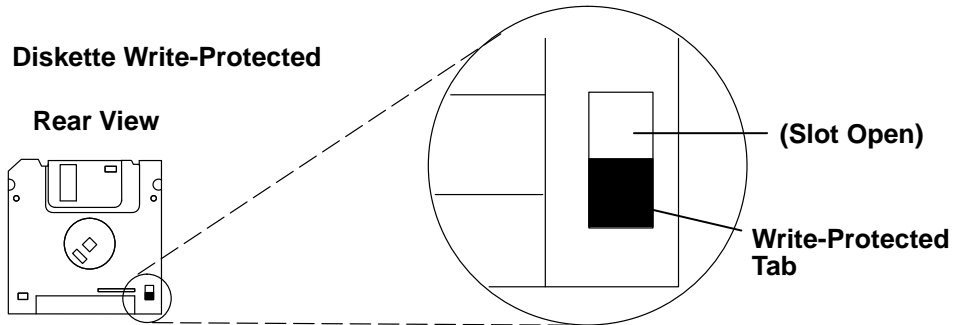

To allow writing onto a diskette, slide the write-protect tab to cover the protect slot.

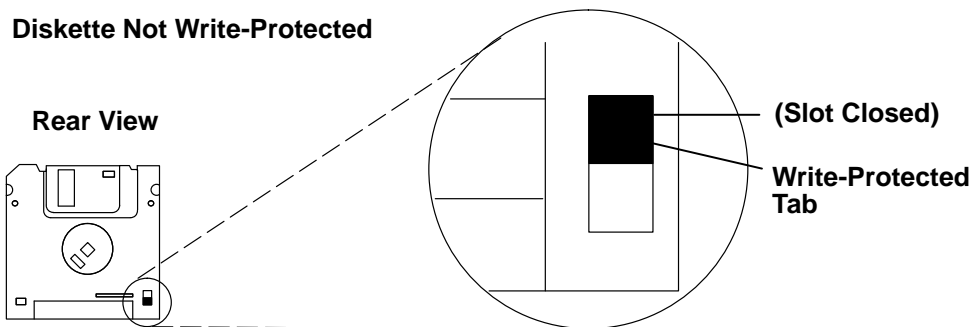

## Loading and Unloading the 3.5-Inch Diskette

To load a diskette into the drive, first insert the diskette in the diskette drive with the labeled metal shutter facing upward. Push the diskette into the drive until you hear a click. The click indicates that the diskette is securely positioned in the drive.

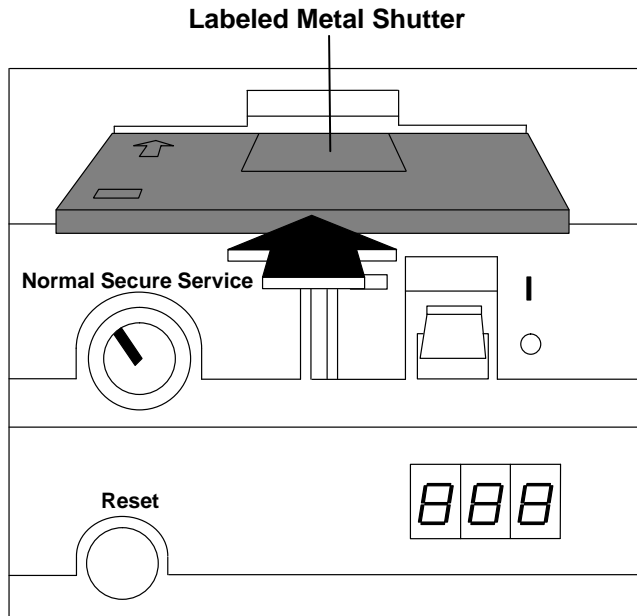

To unload the diskette, push the diskette-unload button. The diskette ejects partially so you can pull out the diskette.

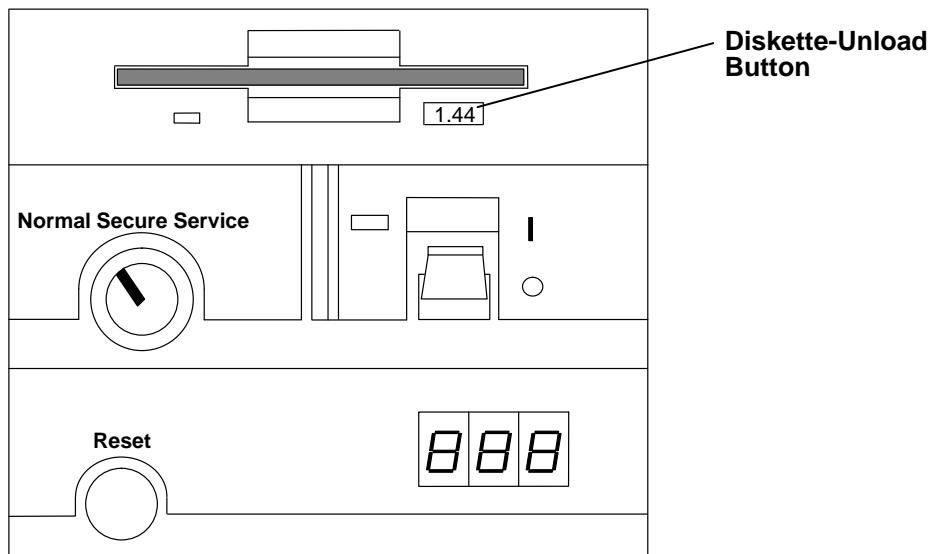

# Using the CD-ROM Drives

## Notes:

1. For a translation of this notice, see *System Unit Safety Information*.
2. This caution only applies to the CD-ROM drive.

## CAUTION:

**A Class 3 laser is contained in the device. Do not attempt to operate the device while it is disassembled. Do not attempt to open the covers of the device, as it is not serviceable and is to be replaced as a unit.**

The CD-ROM drive, an optional feature (standard on some models), is a half-height device. It can occupy only media position C. Your CD-ROM drive looks like one of the two in the illustration, and the controls are located as indicated.

### Type A Bezel (CD-ROM Only):

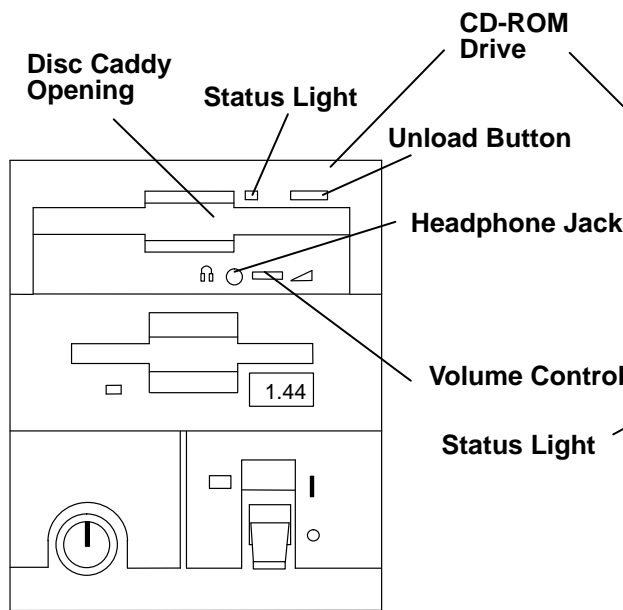

### Type B Bezel (CD-ROM and CD-ROM2):

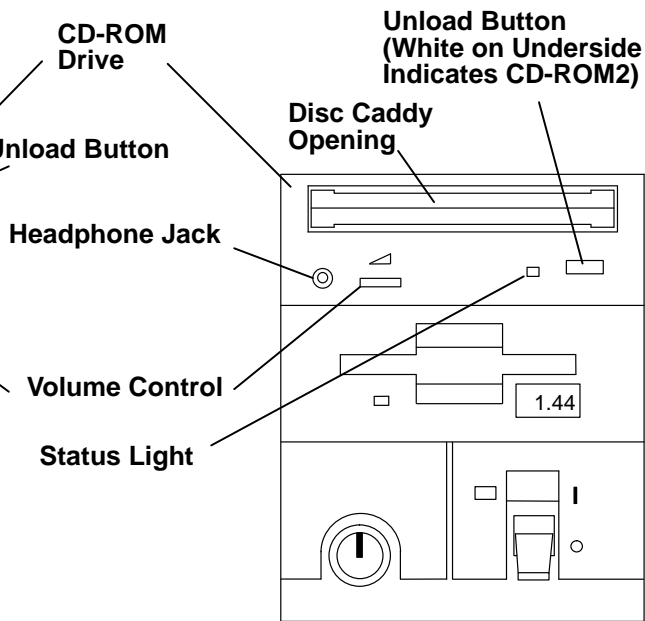

### Type C Bezel:

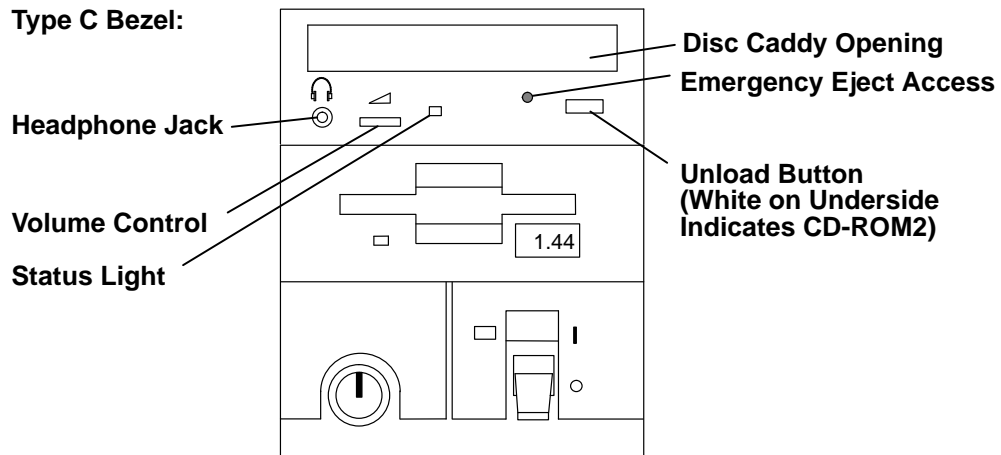

The drive front panel has an unload button, status light, volume control, headphone jack, and disc caddy opening.

When the system unit is set to On, the CD-ROM status light is in one of several conditions. The meanings of the various conditions are as follows:

- Off during standby with the caddy loaded or unloaded.
- Blinks from insertion of the caddy to completion of initialization.
- Blinks slowly when either the lens or disc is dusty (lens should be cleaned by running the cleaning disc).
- Blinks fast when in the audio mode.
- Lights during data transfer operations.
- Lights steady when:
  - No disc is in the caddy.
  - The disc is in the caddy upside down.
  - Some condition exists that should be checked. If this occurs, contact your service representative.

## Loading the CD-ROM Disc Caddy

The CD-ROM media kit contains a CD-ROM diagnostic disc and a disc caddy. Open the disc caddy and place the CD-ROM disc in the caddy with the printed side up.

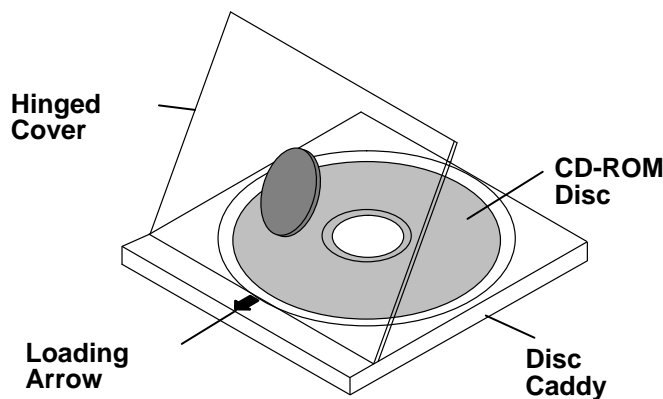

With the loading arrow toward the drive and the printed side of the disc up, insert the caddy in the disc caddy opening. Push gently on the caddy. The drive automatically pulls the caddy into the drive and prepares the disc for reading.

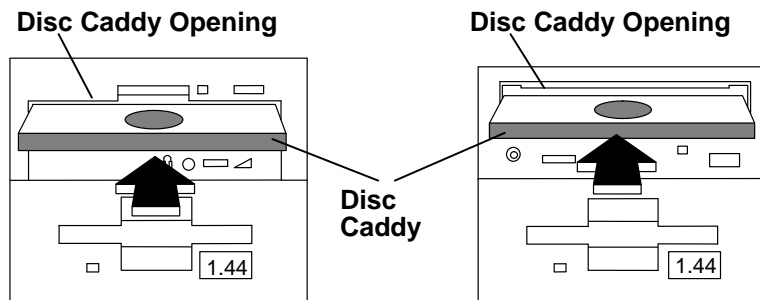

## Loading the CD-ROM Drive (Type C Bezel Only)

Press the unload button to open the tray. Place the disc, with the printed side away from the tray, into the tray. If the CD-ROM drive is in the vertical position, slip out the tabs the first time to hold the disc in place. Push gently on the load/unload button. The drive automatically pulls the tray into the drive and prepares the disc for reading.

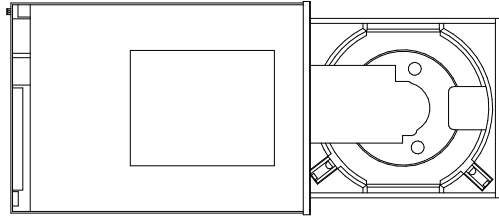

## Unloading the CD-ROM Disc Caddy

Push and hold the unload button until the caddy unloads. The drive partially ejects the caddy from the drive opening. Pull the caddy out of the drive.

**Note:** The unload button must be pushed and held for a minimum of two seconds before the caddy unloads.

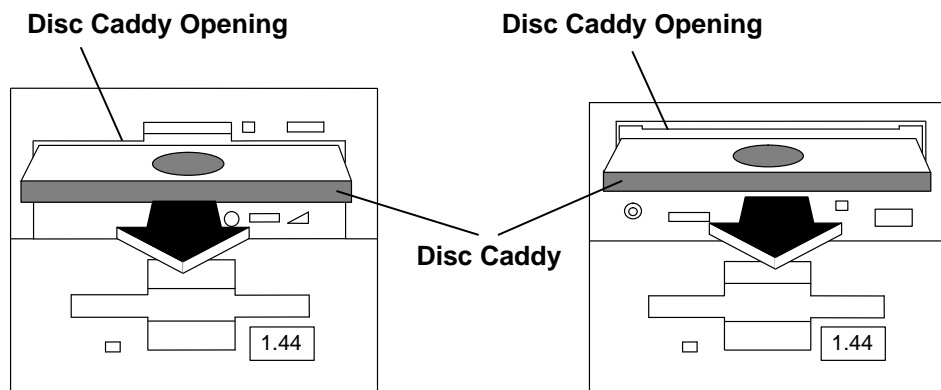

If the disc caddy cannot unload and has to be removed manually from the drive, contact your service representative.

## Unloading the CD-ROM Drive (Type C Bezel Only)

Push and hold the unload button until the tray comes out and then remove the disc.

Type C Bezel:

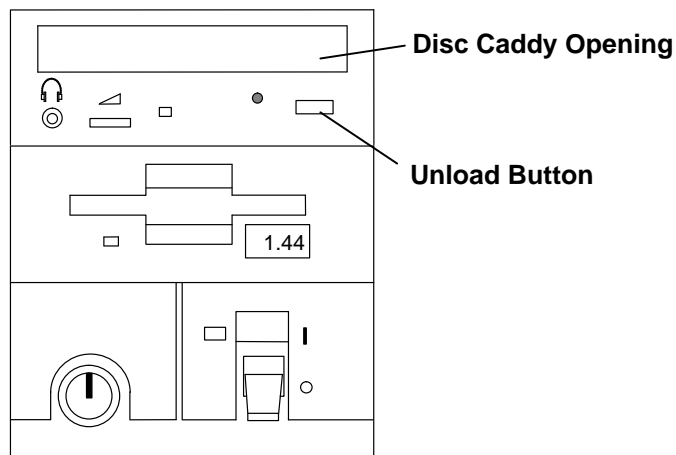

## Cleaning the CD-ROM Drive (Type A)

This CD-ROM internal optic lens needs cleaning if dust or dirt collects on the lens. If this condition exists, the status light blinks slowly when a disc is in the caddy. The lens is cleaned by using the lens cleaning device in the media kit supplied with the drive.

To use the lens cleaning device, follow the instructions on the cover of the device. Use a commercially available cleaning device if a replacement is necessary.

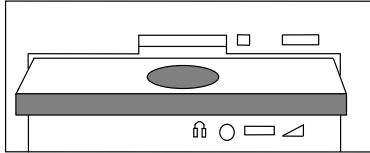

## Cleaning the CD-ROM Drive (Types B and C)

This CD-ROM drive has an internal head-cleaning mechanism, and therefore does not require an external cleaning device. The internal cleaning mechanism cleans the head every time a caddy is inserted into the disc caddy opening.

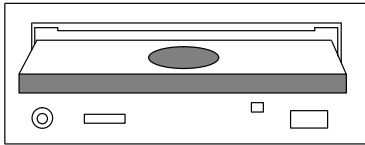

**Note:** Always handle discs by the edges to avoid leaving fingerprints. Discs can be wiped with a soft, lint-free cloth or lens tissue. Always wipe in a straight line from the inner hub to the outer rim.

## Emergency Eject (Type C Bezel Only)

**Note:** Execute the following procedure only in an emergency (drawer will not eject although pressing the unload button).

1. Remove power from the CD-Rom drive.
2. Insert a small diameter rod, such as a paper clip that has been straightened, into the emergency eject hole as shown in the figure.
3. Pull the drawer out.

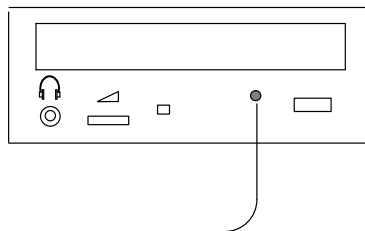

---

## General Information for 2.3 and 5.0GB 8-mm Tape Drives

### Recommendations

- Use only Data Grade 8-mm tape cartridges. These cartridges are identified by either a Data, D, or D8 marking on the data cartridge. Use of video grade cartridges can damage the 8-mm tape drive and can void the warranty of your 8-mm tape drive.
- Remove the tape cartridge from the tape drive when it is not in use, and store the cartridge in the cartridge case.
- Do not open the door on the data tape cartridge. This door covers and protects the magnetic tape material from dirt, dust, and damage.
- Avoid touching the tape since this can cause loss of data.
- Keep the tape drive door closed on the 2.3GB 8-mm tape drive except when loading or unloading a tape cartridge.
- Back up and then discard any tape cartridge that repeatedly produces error messages. The error information is in the system error log.
- Clean the tape path regularly according to the cleaning procedure of the 8-mm tape drive. Use only recommended cleaning cartridges; other cleaning cartridges can permanently damage your 8-mm tape drive.

**Attention:** Do not use video grade cartridges in the 8-mm tape drive. Video grade tapes may be unreliable and may cause permanent damage to the 8-mm tape drive.

### Types of 8-mm Tape Cartridges

Refer to Appendix A for tape cartridge part numbers.

- *Test Tape Cartridge:* This is a specially labeled tape cartridge that is in the media kit with the 8-mm tape drive. Use this cartridge only when checking the operation of the drive or running diagnostics; do not use it to save programs or data.
- *Data Tape Cartridge:* This is a non-labeled blank tape cartridge that is in the media kit. Use this cartridge for saving your programs or data. The same data tape cartridge can be used in either a 2.3GB 8-mm tape drive or a 5.0GB 8-mm tape drive.
- *Cleaning Tape Cartridge:* Use this cartridge for cleaning the 8-mm tape path. For more information, see “Cleaning the Tape Path on the 2.3GB 8-mm Tape Drive” on page 2-25 or “Cleaning the Tape Path on the 5.0GB 8-mm Tape Drive” on page 2-31, depending on your type of 8-mm tape drive.

### Tape Cartridge Compatibility

The 8-mm tape drive is compatible with existing 8-mm tape subsystems that comply to the American National Standard (ANSI) X3B5/89-136, Helical-scan Digital Computer Tape Cartridge, 8-mm for Information Exchange. Data compression effectively increases the cartridge capacity and data transfer rate for the 5.0GB tape cartridges.

8-mm Tape Drive	Format Modes (C = compression mode)			
	2.3GB	2.3GB (C)	5.0GB	5.0GB (C)
2.3GB	Read/Write			
5.0GB	Read/Write	Read only	Read/Write	Read/Write

## Setting the Write-Protect Tab on 8-mm Tape Cartridges

Setting the write-protect tab on a tape cartridge is necessary so that information is not accidentally lost. When the write-protect tab of a tape cartridge is set (window closed), information can be read from the tape, but cannot be written to it.

The window on the tape cartridge controls write-protection.

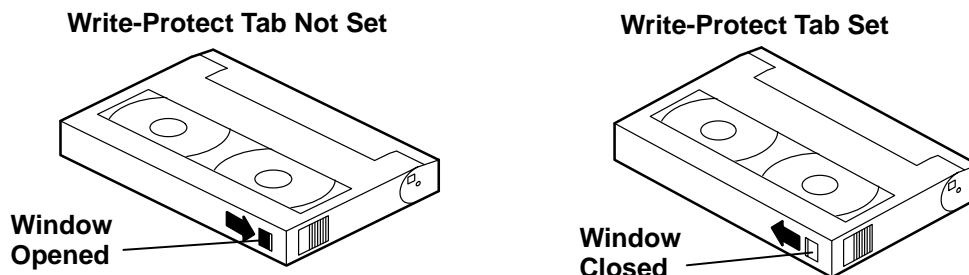

## Environment Considerations for 8-mm Data Cartridges

Information in this section describes operating and storage conditions including temperature, relative humidity, and maximum wet bulb data.

**Attention:** The manufacturer has specified a set of temperature and humidity ranges in which the 8-mm data cartridge can operate with ease. Only regular cleaning procedures are required when operating the cartridge within this range. The risk of possible data loss is increased if 8-mm tape cartridges are operated, stored, or shipped outside the temperature or humidity ranges shown in the following table.

Before using a cartridge, always let it adjust (acclimate) to the operating environment. Do this by placing the cartridge with its container in the operating environment for as long as it has been away from this environment or for 24 hours, whichever is less.

Acclimation is necessary for any data cartridge that has been exposed to a different humidity environment or a temperature change of 11°C or 20°F or more.

	Operating Ranges	Storage	Shipping
Temperature	16°C to 32°C (60°F to 90°F)	5°C to 32°C (40°F to 90°F)	-40°C to 52°C (-40°F to 125°F)
Relative Humidity (noncondensing)	20 to 80%	20 to 80%	20 to 80%
Maximum Wet Bulb	26°C (79°F)	26°C (79°F)	26° C (79°F)

## Operating in Harsh Environments

The 8-mm tape drive is ideally suited to streaming operations, as opposed to tape movement operations involving multiple stop/starts and random searches. When the tape is used for frequent stop and start operations, streaming movement is beneficial and should be used whenever possible. This can be accomplished by ensuring that any save or restore operation is the only active operation performed by a device connected to this SCSI I/O controller.

Any tape that has been used outside the ranges specified in the table on page 2-22 for an extended period of time (50 passes in 40 hours of nonstop operation) should not be used as an archival tape. Exposure to the environment will deteriorate the magnetic and physical strength of the tape. Do not store important data on a tape that has been used outside the specified ranges; transfer the data to a new tape for reliable archiving.



## 8-mm Data Cartridge Erasure

Most bulk eraser devices do not have the capability to erase 8-mm data cartridges. To properly erase an 8-mm data cartridge with a bulk eraser device, the erasure rating must be at least 1500 oersted.

The 2.3GB and the 5.0GB 8-mm tape drives erase residual data before writing new data on the data tape.

## Tape Cartridge Data Efficiency

The 8-mm tape cartridge efficiency is defined as the amount of data that can be stored on the cartridge. The following variables affect the amount of data that can be stored on a tape cartridge:

- Size of the data file
- Number of file marks per file
- File mark size used
- Compatibility mode (2.3GB or 5.0GB)
- Media rewrites.

The effects of some of these variables are listed in the charts on the following page.

---

## Using the 2.3GB 8-mm Tape Drive

The 2.3GB 8mm tape drive is a full-height device that occupies positions A and B.

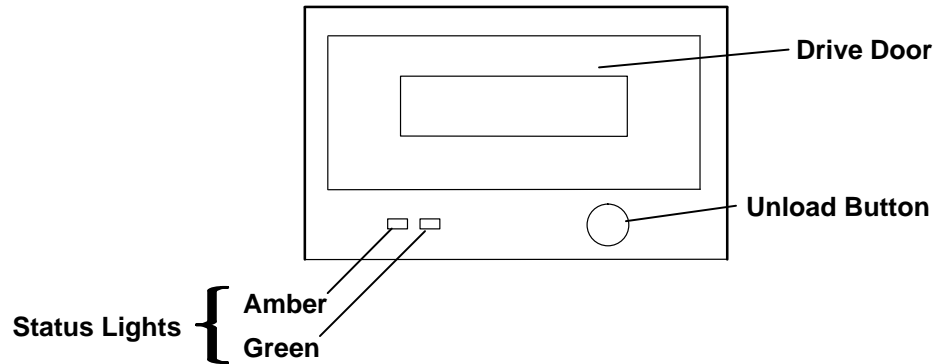

### Status Lights

The following table explains the meaning of the green and amber status lights.

Condition	Status		
	Ready	In Use	Fault
Solid green on, Amber off	Cartridge inserted		
Solid green on, Solid amber on		POST proceeding	
Solid green on, Amber flashing		Busy sending or receiving data	
Green off, Solid amber on			Error cannot be overcome. If this occurs, <i>see the following note.</i>

**Note:** If a fault or an error condition occurs, first try to recover by pressing the unload button. If this does not correct the fault, switch off the power to the 8-mm tape drive and then switch on the power to the drive. If the condition continues, call your service representative.

## Loading the 8-mm Tape Cartridge

To load a tape cartridge, push the unload button. When the button is pushed, the drive door opens and a cartridge tray comes out of the 8-mm tape drive, allowing insertion of the cartridge into the tray. Insert the cartridge, and then gently push the tray into the drive until the drive door closes. The drive loads the tape from the cartridge and prepares it for reading and writing.

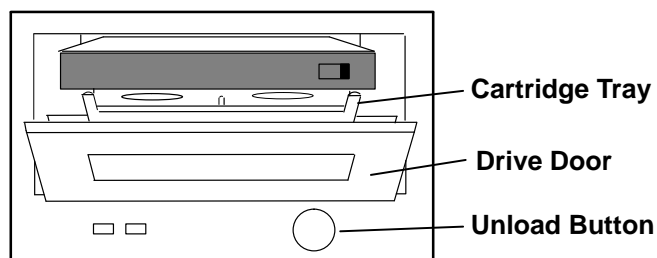

The tape takes about 25 seconds to load. When the green light comes on, the drive is ready for data operations.

Commands can be entered while the tape is loading. Any commands to the tape drive start running once the tape has finished loading. Commands not requiring the tape cartridge are run immediately.

## Unloading the 8-mm Tape Cartridge

Push the unload button. The drive will rewind the tape within the cartridge and partially eject the tray containing the cartridge from the drive opening. Remove the tape cartridge from the tray and push the tray gently into the drive until the drive door closes.

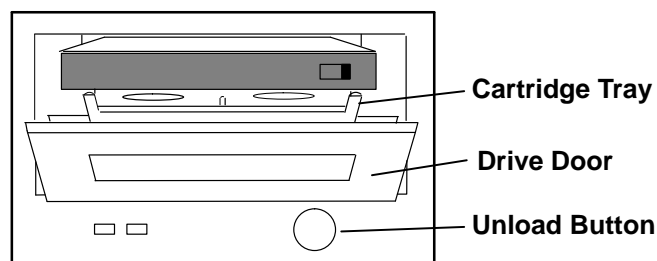

The time required for a tape to rewind and unload is between 18 seconds and 3 minutes, depending on the position of the tape when the unload button is pushed.

If the tape cartridge cannot unload and has to be removed manually from the drive, contact your service representative.

## Cleaning the Tape Path on the 2.3GB 8-mm Tape Drive

**Attention:** Do not use video cleaning cartridges in the 8-mm tape drive. Video cleaning cartridges can damage the 8-mm tape drive.

The read-write heads should be cleaned approximately every 30 hours of tape motion (30 gigabytes of data transfer). More frequent cleaning may be required if the drive is operated in a dusty environment or in humid conditions. In these conditions, the cleaning frequency may be as often as once every 5 hours of tape movement.

If the dust is allowed to accumulate, the drive has to perform more reads and writes. This can cause data loss, and may be prevented by regularly scheduled cleaning of the drive.

The cleaning cartridge cleans the 8-mm tape drive 12 times before it needs to be discarded. If all of the tape is on the right take-up reel, the cleaning cartridge is completely used and must be discarded. If you continue to use this cleaning cartridge, it will not clean the drive, and there is no indication that the cleaning operation was not performed.

Some video cleaning cartridges are extremely abrasive and an 8-mm drive may be permanently damaged after only a few cleaning operations using an abrasive-type cleaning cartridge.

To clean the tape path, load a cleaning cartridge into the tape drive by doing the following:

1. Push the unload button. When the button is pushed, the drive door opens and the cartridge tray comes out of the 8-mm tape drive, allowing insertion of the cartridge into the tray.
2. Insert the cleaning cartridge (PN 21F8593), and then gently push the tray into the drive until the drive door closes. The drive automatically loads the tape from the cartridge and cleans the tape path.
3. Wait for the drive to perform the cleaning operation, and eject the cartridge. The total cleaning time is approximately 30 seconds. If the drive does not automatically unload the cartridge in 30 seconds, push the unload button and remove the cartridge.

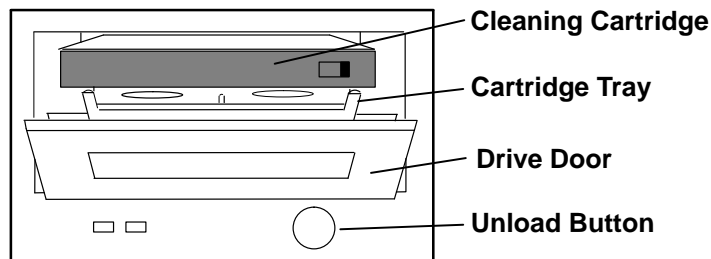

---



## Using the 5.0GB 8-mm Tape Drive

The optional 5.0GB 8-mm tape drive is a half-height device that occupies drive position A only.

### Status Lights

The 5.0GB 8-mm tape drive has two green status lights and one amber status light. The on and off combinations of the status lights indicate the conditions of the 8-mm tape drive.





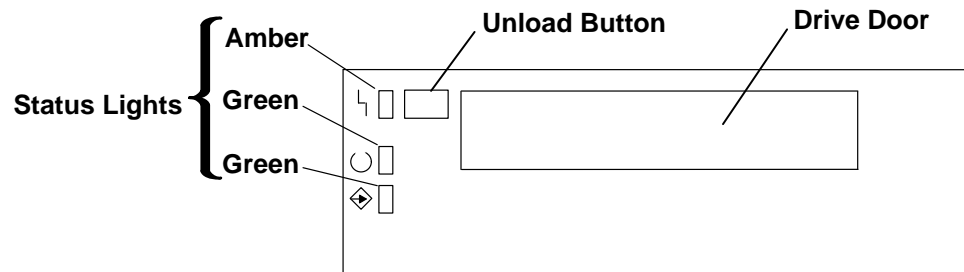













































Each of the International Organization for Standards (ISO) symbols located next to a status light indicates a specific condition of the tape drive as follows:

-  Disturbance (amber status light)
-  Ready (green status light)
-  Busy (green status light)



## Status Light States

The following table explains the meaning of the green and amber status lights.

Status Lights on the 5.0GB 8-mm Tape Drive		
Status Lights	State	Status
     	On On On	The power-on self-test (POST) is running or the system has issued a Reset to the drive.
     	Off Off Off	One of the following has occurred: <ul style="list-style-type: none"> <li>The power is off.</li> <li>The POST has completed successfully, but no tape cartridge has been inserted.</li> </ul>
     	Off On Off	A tape cartridge has been inserted and the 8-mm tape drive is ready to receive commands from the system.
     	Off Off Flashing	A tape cartridge has been inserted and the 8-mm tape drive is performing a tape load or unload operation.
     	Off On Flashing	The tape is in motion and the 8-mm tape drive is busy running a device operation.
     	Flashing Off Off	The 8-mm tape drive has detected an internal fault that requires corrective action. If this occurs, see the following note.
    or    or 	On Off or On Off or Flashing	The tape path requires cleaning. Refer to "Cleaning the Tape Path on the 5.0GB 8-mm Tape Drive" on page 2-31.
<b>Legend:</b>	 Disturbance  Ready  Busy	 On  Off  Flashing

**Note:** If a fault or an error condition occurs, first try to recover by pressing the unload button. If this does not correct the fault, switch off the power to the 8-mm tape drive and then switch on the power to the drive. If the condition continues, call your service representative.

## Loading the 8-mm Tape Cartridge

Before loading the tape cartridge, make sure the power is on and the write-protect tab on the tape cartridge is properly set. Refer to "Setting the Write-Protect Tab on 8-mm Tape Cartridges" on page 2-22. The tape drive loads the tape from the cartridge and prepares it for reading and writing.

To load the 8-mm tape cartridge, do the following:

1. Grasp the edges of the 8-mm tape cartridge with the write-protect tab toward you and the window side of the cartridge facing up.
2. Slide the tape cartridge into the opening on the front of the 8-mm tape drive until the loading mechanism pulls the cartridge into the drive and the drive door closes. The ready status light (green) will go on if the load operation was successful.

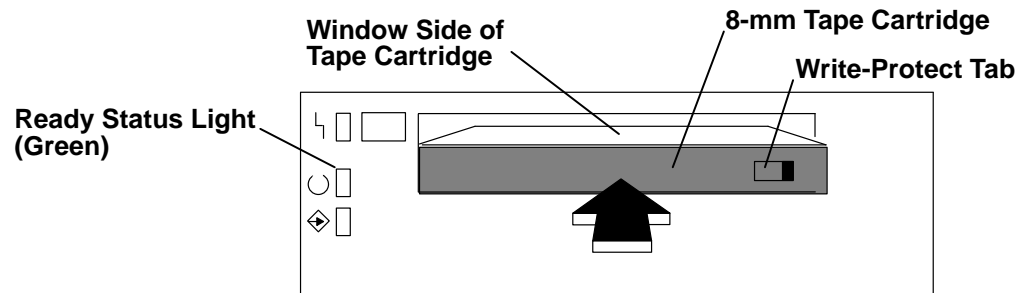

The 8-mm tape drive is ready for data operations when the tape cartridge is inserted. After the cartridge is inserted into the tape drive, the tape takes about 25 seconds to load; this does not interfere with beginning the data operations.

Commands can be entered while the tape is loading. Any commands to the tape drive start running once the tape has finished loading. Commands not requiring the tape cartridge are run immediately.

## Unloading the 8-mm Tape Cartridge

Before performing the unload operation, make sure the power to the 8-mm tape drive is on.

To unload and eject the tape cartridge, press the unload button. The 8-mm tape drive rewinds the tape and then ejects the tape cartridge from the tape drive.

After pressing the unload button, the following will occur:

1. The ready ○ status light will go off.
2. The busy ◇ status light will flash during the unload operation.
3. The busy ◇ status light will go off when the cartridge is ejected from the tape drive.

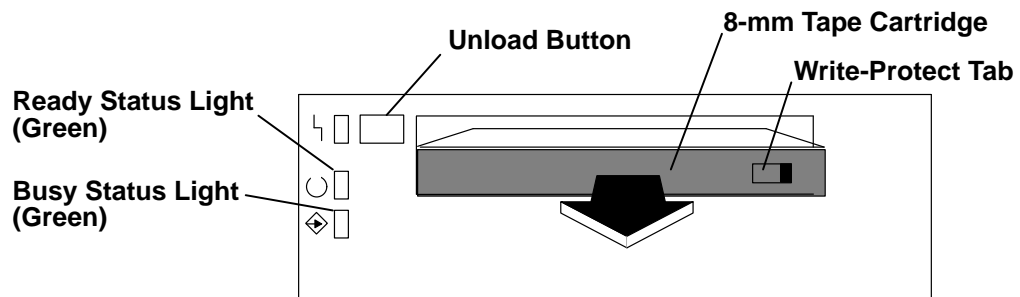

The time required for a tape to rewind and unload is between 18 seconds and 3 minutes, depending on the position of the tape when the unload button is pushed.

If the tape cartridge cannot unload and has to be removed manually from the drive, contact your service representative.



## Cleaning the Tape Path on the 5.0GB 8-mm Tape Drive

**Attention:** Do not use video cleaning cartridges in the 8-mm tape drive. Video cleaning cartridges can damage the 8-mm tape drive.

The 8-mm tape path should be cleaned either approximately every 30 hours of tape motion or once a month, whichever occurs first. The 5.0GB 8-mm tape drive counts the number of hours of tape motion and indicates when the tape path requires cleaning when the lighted disturbance status light (amber) is on.

More frequent cleaning may be required if the drive is operated in a dusty environment or in humid conditions. If the dust is allowed to accumulate, the drive has to perform more reads and writes. This can cause data loss, and may be prevented by regularly scheduled cleaning of the drive.

The cleaning cartridge cleans the 8-mm tape drive 12 times before it needs to be discarded. If you attempt to use an 8-mm cleaning cartridge more than 12 times, the tape drive automatically detects the error and ejects the cleaning cartridge with the disturbance status light (amber) remaining on.

Some video cleaning cartridges are extremely abrasive. An 8-mm tape drive may be permanently damaged after only a few cleaning operations using an abrasive-type cleaning cartridge.

Before loading the cleaning cartridge, make sure the power to the 8-mm tape drive is on.

To load the 8-mm cleaning cartridge, do the following:

1. Grasp the edges of the 8-mm cleaning cartridge with the window side of the cartridge facing up.
2. Slide the cleaning cartridge into the opening on the front of the 8-mm tape drive until the loading mechanism pulls the cartridge into the drive.

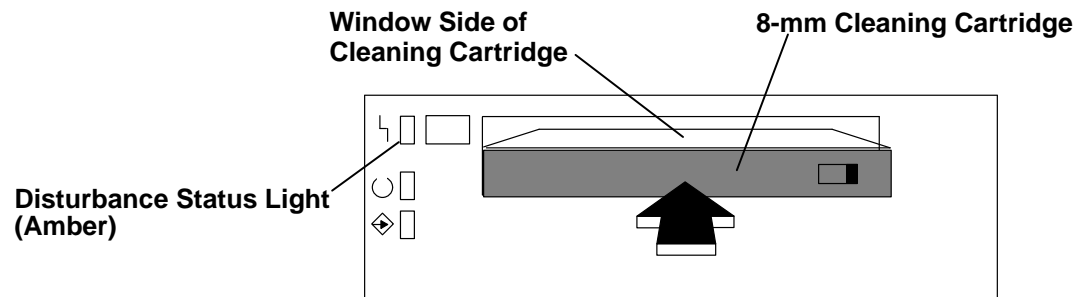

After the 8-mm cleaning cartridge has been fully inserted into the 8-mm tape drive, the following cleaning operations are performed automatically:

1. The cleaning tape is loaded into the tape path.
2. The drive is cleaned by moving the cleaning tape forward for approximately two minutes.
3. The tape is unloaded and the cleaning cartridge is ejected from the tape drive when the cleaning operation is complete.
4. A successful cleaning operation is indicated when the disturbance status light (amber) goes off.

---

## General Information for 4.0GB 4-mm Tape Drive

The 4.0GB 4-mm tape drive is an internal streaming tape drive that is used to:

- Save and restore system data files.
- Archive important records.
- Distribute operating system software upgrades.

The 4-mm tape drive is designed to be attached to any system using a single-ended interface meeting the Small Computer System Interface II (SCSI-II) Standard ANSI X3.131-199X Rev. 10h.

The 4-mm tape drive has the following features:

- Capacity of 4.0 GB per cartridge. 8 GB is typical with data compression and with DDS2 data cartridges.

The actual capacity per cartridge varies depending on the application and the type of data cartridge being used.

- Data transfer rate is 400 KBps. 800 KBps is typical with data compression.

**Note:** Data compression activated is the default setting from the factory. Data compression is usually controlled by the application software.

- Read and write of DDS|||| tape cartridges in 2.0 GB per cartridge format.
- A status light that indicates when it is time to clean the tape path.
- Internal diagnostics that are activated when the 4-mm Diagnostic Cartridge is inserted and loaded into the drive.
- Media recognition system: only *data grade* media can be used with this tape drive.

The 4-mm tape drive uses a 4-mm data cartridge for saving and restoring your system data. The 4-mm tape drive is designed to use only 4-mm Digital Data Storage (DDS) cartridges. These cartridges are identified by the DDS symbols (shown below) somewhere on the data cartridge.



## Recommendations

**Attention:** Tape cartridges that do not carry the proper DDS symbol cannot be written to and their use will cause the 4-mm tape drive to report an error.

- Use only 4-mm Digital Data Storage (DDS) cartridges.

**Attention:** Use of other than recommended cleaning cartridges can damage your tape drive and will void the drive warranty.

- Clean the tape path by using the recommended cleaning cartridge. Follow the instructions on the cartridge.
- Back up and then discard any tape cartridge that repeatedly produces error messages. The error information is in the system error log.
- Do *not* open the door on the data cartridge that covers the tape. This door protects the magnetic tape material from dirt, dust, and damage.
- Do *not* operate in a dusty environment.
- Do *not* touch the tape material. Any substance transferred to the tape by touching it could cause loss of data.

## Types of 4-mm Tape Cartridges

The 4-mm tape drive is shipped with three 4-mm cartridges to help start your tape operations immediately. Refer to Appendix A for tape cartridge part numbers.

*4-mm Data Cartridge:* Use this non-labeled cartridge for saving or restoring your programs or data. Additional data cartridges can be ordered.

*4-mm Diagnostic Cartridge:* Use this specially labeled cartridge to perform diagnostics on the drive. Do *not* use it to save or restore programs or data.

*Cleaning Cartridge:* Use this cartridge for cleaning the 4-mm tape path. For more information, see “Cleaning the Tape Path on the 4.0GB 4-mm Tape Drive” on page 2-40.

## Tape Cartridge Compatibility

The 4-mm Tape Drive is compatible with existing 4-mm tape subsystems that are designed to operate with Digital Data Storage approved media, which meet the following standards:

- For DDS||||
  - American National Standard (ANSI) standard, X3.203-191, *Helical-scan Digital Computer Tape Cartridge, 3.81mm*.
  - European Computer Manufacturers Association (EMCA) standard, EMCA-150, *3.81mm Wide Magnetic Tape Cartridge and DDS|||| format*.
- For DDS2
  - European Computer Manufacturers Association (EMCA) standard, EMCA/TC17/93/20, *3.81mm Wide Magnetic Tape Cartridge for Information Interchange Helical Scan Recording, DDS2 format*.

You cannot change the density setting of the drive, as the device reconfigures itself automatically, depending on the media type installed, as follows:

Media Type	Device Configuration
DDS	Read-only
DDS	Read/write in 2.0GB mode only.
DDS2	Read in either density; write in 4.0GB mode only.
Non-DDS	Not supported. The cartridge will eject.

## Setting the Write-Protect Tab on 4-mm Tape Cartridges

The window on the tape cartridge controls write-protection. When the write-protect tab of a tape cartridge is set (window open), information can be read from the tape, but cannot be written to it. When the write-protect tab of a tape cartridge is not set (window closed), information can be both written to and read from the tape. Trying to write to a 4-mm data cartridge with the window open causes an error.

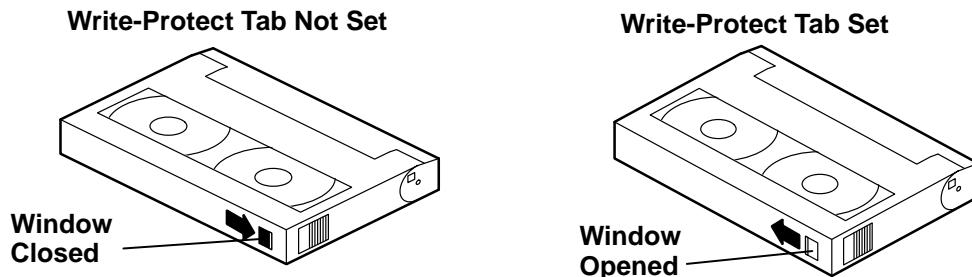

## Environmental Considerations for 4-mm Data Cartridges

Information in this section describes operating and storage conditions including temperature, relative humidity, and maximum wet bulb data.

**Attention:** The manufacturer has specified a set of temperature and humidity ranges in which the 4-mm data cartridge can operate with ease. Only regular cleaning procedures, as described in “Cleaning the Tape Path on the 4.0GB 4-mm Tape Drive” on page 2-40, are required when operating the cartridge within this range. The risk of possible data loss is increased if 4-mm tape cartridges are operated, stored, or shipped outside the temperature or humidity ranges shown in the following table.

Before using a cartridge, always let it adjust (acclimate) to the operating environment. Do this by placing the cartridge with its container in the operating environment for as long as it has been away from this environment or for 24 hours, whichever is less.

Acclimation is necessary for any data cartridge that has been exposed to a different humidity environment or a temperature change of 11°C or 20°F or more.

	Operating Ranges	Storage	Shipping
Temperature	16°C to 32°C (60°F to 90°F)	5°C to 32°C (40°F to 90°F)	-40°C to 52°C (-40°F to 125°F)
Relative Humidity (non-condensing)	20 to 80%	20 to 80%	5 to 80%
Maximum Wet Bulb	26°C (79°F)	26°C (79°F)	26° C (79°F)

## Operating in Harsh Environments

The 4-mm tape drive is ideally suited to streaming operations, as opposed to tape movement operations involving multiple stop/starts and random searches. When the tape is used for frequent stop and start operations, streaming movement is beneficial and should be used whenever possible. This can be accomplished by ensuring that any save or restore operation is the only active operation performed by a device connected to this SCSI I/O controller.

Any tape that has been used outside the ranges specified in the previous table for an extended period of time (50 passes in 40 hours of nonstop operation) should not be used as an archival tape. Exposure to the environment will deteriorate the magnetic and physical strength of the tape. Do not store important data on a tape that has been used outside the specified ranges; transfer the data to a new tape for reliable archiving.

## 4-mm Data Cartridge Erasure

Most bulk eraser devices do not have the capability to erase 4-mm data cartridges. To properly erase an 4-mm data cartridge with a bulk eraser device, the erasure rating must be at least 2000 oersted.

The 4-mm tape drive erases residual data before writing new data on the data tape.

## Tape Cartridge Data Capacity

The 4-mm tape cartridge capacity is defined as the amount of data that can be stored on the cartridge. The following variables affect the amount of data that can be stored on a tape cartridge:

- Size of the data file
- Number of file marks per file
- Compatibility mode (2GB or 4GB)
- Media rewrites.

## Using the 4.0GB 4-mm Tape Drive

The optional 4.0GB 4-mm tape drive is a half-height device that occupies drive position A or B only.

### Status Lights

The 4.0GB 4-mm tape drive has two green status lights and one amber status light. The on and off combinations of the status lights indicate the conditions of the 4-mm tape drive.

Each of the International Organization for Standards (ISO) symbols located next to a status light indicates a specific condition of the tape drive as follows:



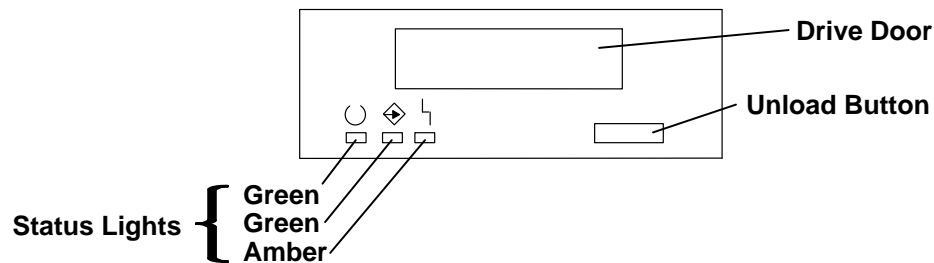







- Ready (green status light)
- ◊ Read-Write (green status light)
- ⚡ Disturbance (amber status light)



### Status Light States

The following tables explain the meaning of the green and amber status lights.

	○ Ready (green)	◊ Read-Write (green)	⚡ Disturbance (amber)
Off	No cartridge installed or fault condition	No cartridge or no activity	No fault condition
Steady	Cartridge installed or loading/unloading		Cleaning required or worn media
Flashing	Power-on self-test in progress	Cartridge activity	Fault condition

Status Lights on the 4.0GB 4-mm Tape Drive			
Status	 Ready (green)	 Read-Write (green)	 Disturbance (amber)
LED test.	On 2 seconds at power on	On 2 seconds at power on	On 2 seconds at power on
The power-on self-test (POST) is running or the Diagnostic Cartridge is running.	 Flashing	<input type="checkbox"/> Off	<input type="checkbox"/> Off
One of the following has occurred: <ul style="list-style-type: none"> <li>The power is off.</li> <li>The POST has completed successfully, but no tape cartridge has been loaded.</li> </ul>	<input type="checkbox"/> Off	<input type="checkbox"/> Off	<input type="checkbox"/> Off
A tape cartridge has been inserted and the 4-mm Tape Drive is Ready to receive commands from the system.	 On	<input type="checkbox"/> Off	<input type="checkbox"/> Off
The tape is in motion and the 4-mm Tape Drive is running a device operation or cleaning.	 On	 Flashing	<input type="checkbox"/> Off
The 4-mm Tape Drive has detected an internal fault that requires corrective action such as tape cartridge failure, high humidity, or no SCSI terminator. Refer to the service guide or contact your service representative. (See note below)	<input type="checkbox"/> Off	<input type="checkbox"/> Off	 Flashing
The tape path requires cleaning or a poor quality tape cartridge is being used. See "Cleaning the Tape Path on the 4.0GB 4-mm Tape Drive" on page 2-40	<input type="checkbox"/> Off or  On	<input type="checkbox"/> Off or  Flashing	 On

**Note:** If a fault or an error condition occurs, first try to recover by pressing the unload button. If this does not correct the fault, switch off the power to the 4-mm tape drive and then switch on the power to the drive. If the condition continues, call your service representative.

## Loading the 4-mm Tape Cartridge

Before loading the tape cartridge, make sure the power is on and the write-protect switch on the tape cartridge is properly set. Refer to “Setting the Write-Protect Tab on 4-mm Tape Cartridges” on page 2-34. The tape drive loads the tape from the cartridge and prepares it for reading and writing.

To load the 4-mm tape cartridge, do the following:

1. Grasp the edges of the 4-mm tape cartridge with the write-protect tab towards you and the window side of the cartridge facing up.
2. Slide the tape cartridge into the opening on the front of the 4-mm tape drive until the loading mechanism pulls the cartridge into the drive and the drive door closes. The ready status light (green) will go on if the load operation was successful.

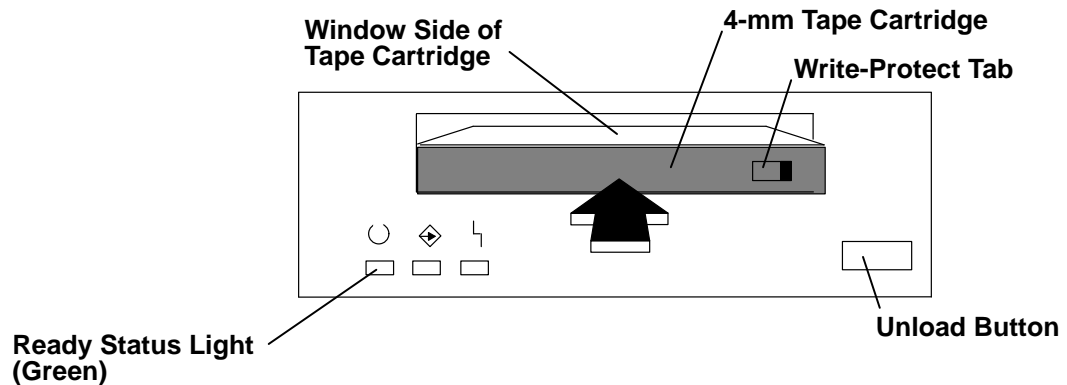

The 4-mm tape drive is ready for data operations when the tape cartridge is inserted. After the cartridge is inserted into the tape drive, the tape takes about 15 seconds to load.





## Unloading the 4-mm Tape Cartridge

Before performing the unload operation, make sure the power to the 4-mm tape drive is on.

To unload and eject the tape cartridge, press the unload button. The 4-mm tape drive rewinds the tape and then ejects the tape cartridge from the tape drive.

After pressing the unload button, the following will occur:

1. The Read-Write  status light will flash during the unload operation.
2. The Ready  status light and the Read-Write  status light will turn off when the cartridge is ejected from the tape drive.

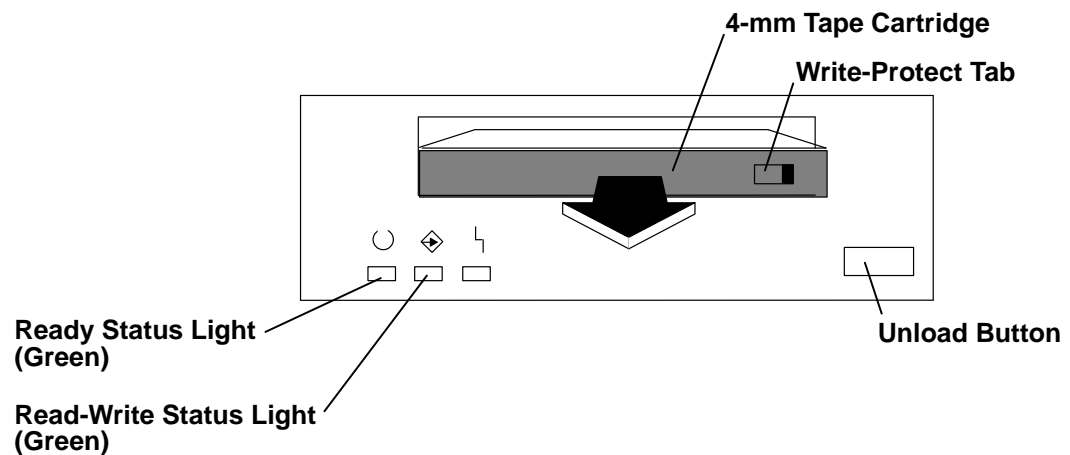

The time required for a tape to rewind and unload is between 10 seconds and 1.5 minutes, depending on the position of the tape when the unload button is pushed.

If the tape cartridge cannot unload and has to be removed manually from the drive, see “Manually Removing the Tape Cartridge” in *POWERstation and POWERserver Common Diagnostics Information For Micro Channel Bus Systems*.

## Cleaning the Tape Path on the 4.0GB 4-mm Tape Drive

The 4-mm tape path should be cleaned either approximately every 30 hours of tape motion or once a month, whichever occurs first. The 4-mm tape drive monitors the recording quality of the tape cartridge and indicates that the tape path requires cleaning when the disturbance status light (amber) is on.

More frequent cleaning may be required if the drive is operated in a dusty environment or in humid conditions. If the dust is allowed to accumulate, the drive has to perform more reads and writes. This can cause data loss, and may be prevented by regularly scheduled cleaning of the drive.

The cleaning cartridge cleans the 4-mm tape drive 50 times before it needs to be discarded. If you attempt to use a 4-mm cleaning cartridge more than 50 times, the tape drive automatically detects the error and ejects the cleaning cartridge with the disturbance status light (amber) remaining on.

Before loading the cleaning cartridge, make sure the power to the 4-mm tape drive is on.

To load the 4-mm cleaning cartridge, do the following:

1. Grasp the edges of the 4-mm cleaning cartridge with the window side of the cartridge facing up.
2. Slide the cleaning cartridge into the opening on the front of the 4-mm tape drive until the loading mechanism pulls the cartridge into the drive.

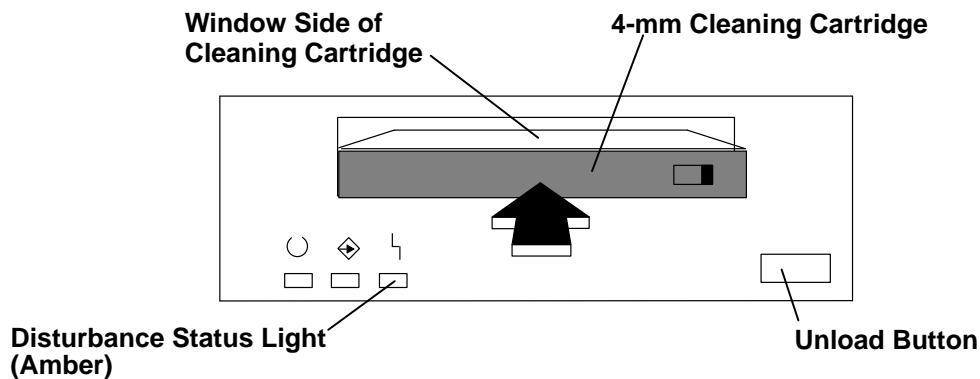

After the 4-mm cleaning cartridge has been fully inserted into the 4-mm tape drive, the following cleaning operations are performed automatically:

1. The cleaning tape is loaded into the tape path.
2. The drive is cleaned by moving the cleaning tape forward for approximately 30 seconds.
3. The tape is unloaded and the cleaning cartridge is ejected from the tape drive when the cleaning operation is complete.
4. A successful cleaning operation is indicated when the disturbance status light (amber) goes off (if it was activated before the cleaning operation).

---

## Using the 1/4-inch Tape Drive

The QIC tape has the following characteristics:

- Capacity 1.2GB
- Media data transfer 300KB/sec
- Form factor 5-1/4 inch
- Read and write compatibility with QIC 120, 150, 525, and 1000 media

### Functions

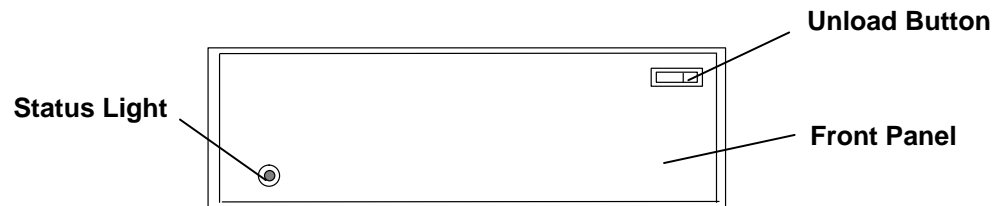

The status light has no color when it is off. When the status light is on, it may be either green or red. The colors indicate the status of the drive as follows.

#### Status light

A green light indicates the drive is in normal operation.

A red light indicates there is a problem with the drive.

When the light is off, the drive is waiting in standby mode.

#### Unload button

Press to unload the tape from the drive.

## Loading the Tape

A diagram inside the drive door shows how to load a tape. To load a tape cartridge, push the unload button. When the button is pushed, the front panel of the drive partially opens toward the front of the system unit.

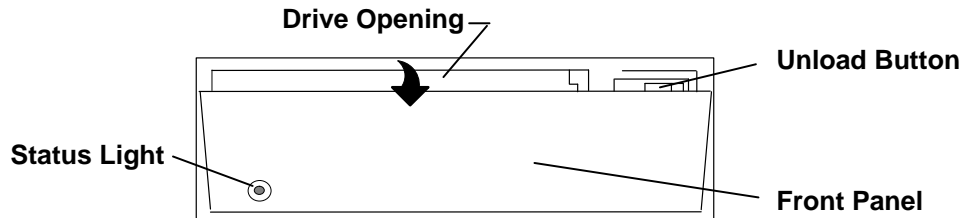

1. Pull the front panel open all the way to the flat position, where it will stay without having to be held open.

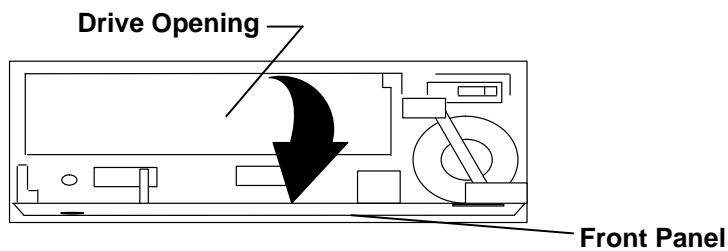

2. Insert the cartridge into the drive opening as shown. Gently push the cartridge into the drive opening until the cartridge stops.



3. Close the front panel until you hear an audible click.

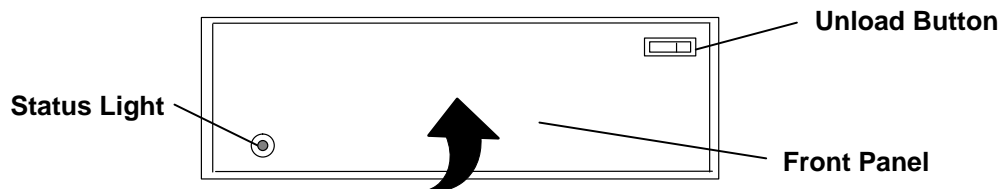

The drive loads the tape from the cartridge and prepares it for reading and writing.

Once the cartridge has been inserted and the front panel closed, it will automatically rewind to the beginning of the tape.

## Unloading the Tape

To unload the tape, use the same procedure as you did for loading except pull the cartridge from the drive opening.

1. Push the unload button.
2. Pull the front panel open (flat).
3. Pull the tape cartridge out of the drive.
4. Push the front panel closed.

## Tape Cartridge Data Efficiency

**Note:** For maximum efficiency, operate the 1/4 inch tape drive in the streaming mode whenever possible.

The 1/4 inch tape cartridge efficiency is defined as the amount of data that can be stored on the cartridge and the data rate at which the data can be read from the tape cartridge. When in use, the tape in the cartridge moves at a constant speed of 72 inches per second.

The following variables affect the amount of data that can be stored on a tape cartridge:

- Streaming mode or nonstreaming mode
- Size of the data file
- Number of file marks per file
- Tape length
- Variable post/preamble
- Compatibility Mode (QIC120/QIC150/QIC525/QIC1000).

## Setting the Write-Protect Tab on 1/4 Inch Tape Cartridges

Setting the write-protect tab on a tape cartridge is necessary so that information is not accidentally lost. When the write-protect tab of a tape cartridge is set (pointing to SAFE), information can be read from the tape, but cannot be written to it.

The write-protect tab positions for a typical cartridge are shown in the following illustration. Use a small screwdriver to turn the arrow to the desired position. The arrow must be pointing in one of the two directions shown in the illustration.

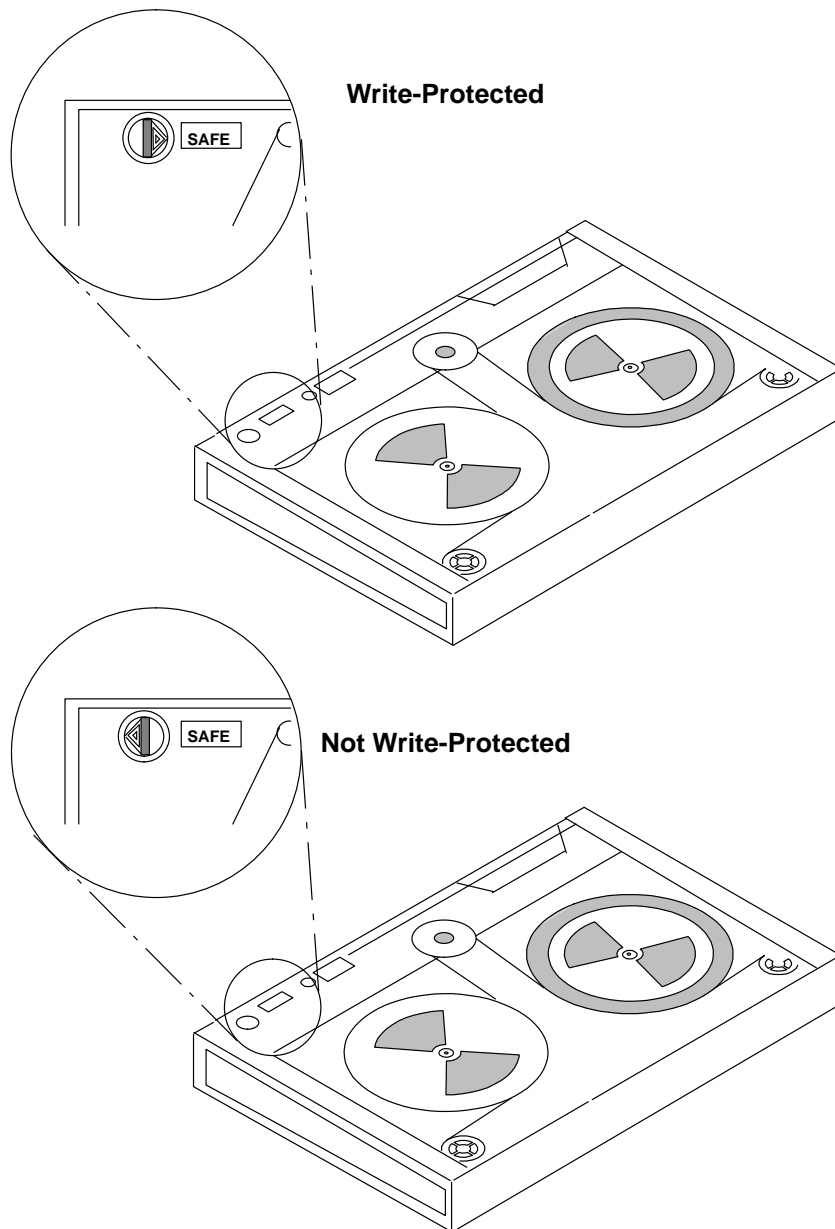

## Retensioning

The tape drive works best when it is operated as a streaming tape. If the tape cartridge has been operated in the streaming mode, it is not necessary to retension the tape. If the tape is used in a nonstreaming mode (many start and stop operations), retension the tape after approximately every 30 minutes.

If the tape drive is on when a tape cartridge is inserted, the drive immediately retensions the tape. Operating system commands may be used to change this default setting. Refer to the operating system commands manual for your system for more information.

## Cleaning the 1/4 Inch Cartridge Drive

It is recommended to clean the read/write heads:

- After any period of 8 hours use
- After the first use of a new cartridge.

The frequency of cleaning depends on the number of hours of daily use, on average, once a week.

For effective cleaning, use a 1/4 inch tape unit cleaning cartridge.

Whenever a new tape unit is brought into service, the following operations should be performed:

- A complete cycle of winding and rewinding, which has two results:
  - Tightens the magnetic tapes
  - Cleans the magnetic medium.
- The tape unit should be cleaned with the cleaning kit.

It is also necessary to carry out a winding and rewinding cycle on any tape unit that has not been used recently.

## Environment Considerations for 1/4 Inch Tape Cartridges

Information in this section describes operating and storage conditions including temperature, relative humidity, and maximum wet bulb data.

**Attention:** The manufacturer has specified a set of temperature and humidity ranges in which the 1/4 inch data cartridge can operate with ease. Only regular cleaning procedures are required when operating the cartridge within this range. The risk of possible data loss is increased if 1/4 inch tape cartridges are operated, stored, or shipped outside the temperature or humidity ranges shown in the following table.

Before using a cartridge, always let it adjust (acclimate) to the operating environment. Do this by placing the cartridge with its container in the operating environment for as long as it has been away from this environment or for 24 hours, whichever is less.

Acclimation is necessary for any data cartridge that has been exposed to a different humidity environment or a temperature change of 11°C or 20°F, or more.

Environment Operating Ranges		
	Operating Ranges	Nonoperating Ranges
Temperature Requirements	16 to 32°C (60 to 90°F)	10 to 43° C (50 to 110°F)
Relative Humidity Requirements (noncondensing)	20 to 80%	20 to 80%
Maximum Wet Bulb Limits	26°C (79°F)	27° C (80°F)

## Tape Cartridge Compatibility

The 1/4 inch tape drive is a medium-capacity small computer system interface (SCSI) tape drive. This drive is compatible with existing 1/4 inch streaming tape subsystems, which use the Quarter-Inch Cartridge Drive Standards, Inc. (QIC) formats.





---

## Chapter 3. Using the Diagnostics

This chapter contains information about using and interpreting the diagnostics used on the system unit.

---

### Sources for the Diagnostic Programs

The diagnostic programs are shipped on three sources, however, a fourth source is available.

The first source is part of the AIX operating system (on disk). The diagnostic programs, included as part of the AIX operating system, are installed along with the operating system. These diagnostic programs are also updated with the AIX operating system.

The second source is on diskettes shipped with system units that do not come with a CD-ROM standard. The diagnostic diskettes shipped with the system unit contain diagnostic programs that can be run in *standalone mode* only. These diagnostic programs contain a special version the operating system. The special version of the AIX operating system only supports the diagnostic programs and cannot be used for normal system activity.

The third source is a CD-ROM disc. The diagnostics are available on a CD-ROM disc for those systems equipped with a CD-ROM drive.

The diagnostic diskettes or the CD-ROM diagnostic disc are the only diagnostic programs available to a system that does not have the AIX operating system installed and the system does not have built-in ROM diagnostics.

The fourth available source is from a network. If your system unit has been configured to receive initial program load (IPL) from a server over a network, then the diagnostics can also be loaded and run from the network.

---

### Diagnostic Programs Operating Considerations

The following items identify some things to consider before using the diagnostic programs.

#### Diagnostics on a System Unit Attached to Another System

If your system unit is attached to another system using a network or directly attached to the channel of another system, see “Operating with Multiple Attached Systems” on page 2-5 before running any diagnostic procedures.

#### Selecting a Console Display

When you run diagnostics from diskettes, from a CD-ROM disc, and under some conditions when you run them from disk, you need to select the console display. The diagnostic programs display `c31` in the three-digit display and display instructions on any direct-attached displays and the terminal attached to the S1 port.

If `c31` is displayed, follow the instructions to select the console display. If you do not have a console display, set the key mode switch to Normal and then back to Service. This signals the diagnostic programs to use the three-digit display for instructions.

## Identifying the Terminal Type to the AIX Operating System

**Note:** This is a different function than selecting a console display.

When you run diagnostics, the AIX operating system must know which type of terminal you are using. If the terminal type is not known when the FUNCTION SELECTION menu is displayed, the diagnostics do not allow you to continue until you select a terminal. Use the DEFINE TERMINAL option menu to select the terminal type. Select `hft` for adapter-attached displays. This option sets the TERM environment variable in the AIX operating system.

### Undefined Terminal Types

If an undefined terminal type from the DEFINE TERMINAL option menu is entered, the menu will prompt the user to enter a valid terminal type, and the menu will be redisplayed until either a valid type is entered or the user exits the DEFINE TERMINAL option.

#### Resetting the Terminal

If the user enters a terminal type that is valid (according to the DEFINE TERMINAL option menu) but is not the correct type for the ASCII terminal being used, difficulty may be encountered in reading the screen, using the function keys or using the Enter key. These difficulties can be bypassed by pressing `Ctrl-C` to reset the terminal. The screen display which results from this resetting action varies with the mode in which the system is being run:

- Normal or Maintenance mode – The command prompt appears.
- Service mode – The terminal type will be reset to “dumb”, the Diagnostic Operating Instruction panel will be displayed, and the user will be required to go through the DEFINE TERMINAL process again.

## Running the Diagnostic Programs from Diskettes

Consider the following when you run the diagnostic programs from diskettes:

- The diagnostic diskettes are labeled as to the devices and functions the diskettes contain. The following diskettes must be inserted in the order shown before the DIAGNOSTIC OPERATING INSTRUCTIONS will be displayed.
  1. Boot diskette
  2. Configuration diskette
  3. Graphics diskette (optional if the system does not contain a graphics adapter)
  4. Console Definition diskette.
- There are two different boot diskettes, one for use in systems containing only 8 MB of memory and one for use in systems containing a minimum of 16 MB of memory. Only one diskette can be loaded.

**Note:** When using the 8MB boot diskette only the following devices/adapters may be tested:

- Base system (floating point, memory, I/O planar)
- Async adapters
- Graphic adapters
- Keyboard
- Media devices
- SCSI adapters

The devices listed will only show on the test list if they are normally supported in an 8MB system. All other devices and adapters will not appear on the test list.

- There are several different graphics diskettes for configuring and testing graphics adapters. Use only the graphics diskettes for the type of graphics adapters installed in the system. For each type of graphics adapter installed in a system, you must load the graphics diskette which supports that adapter in order to test it.

The diskette containing the graphics adapter that will be used as the console for running diagnostics should be loaded first. If there are other graphics adapter types installed in the system, load the diskette supporting those adapters immediately following the first graphics diskette.

- If a device installed in a system is not supported by one of the diskettes shipped with the system, check for the existence of a supplemental diagnostic diskette shipped with the device.
- After the `DIAGNOSTIC OPERATING INSTRUCTIONS` are displayed, follow the displayed instructions to test the device or to run a service aid.
- The diagnostic programs shipped on diskettes with the system unit have a version number on the label. The *POWERstation and POWERserver Common Diagnostics Information For Micro Channel Bus Systems* also has a version number on the cover. The first two digits of these version numbers should match for diagnostics to work correctly. You can check the version of the diagnostic programs on the `DIAGNOSTIC OPERATING INSTRUCTIONS`.
- When you load the diagnostic programs from diskettes, you may get the following messages on the three-digit display or on the console display:

c01	Insert the first diagnostic diskette.
c02	Diskettes inserted out of sequence.
c03	The wrong diskette is in the diskette drive.
c05	A diskette error occurred.
c07	Insert the next diagnostic diskette.
c09	Diskette is being read or written.
c31	Select the console display.

## Running the Diskette Diagnostics from a Non-RS-232 Terminal

Version 1.3 and later versions of the Diagnostic Diskette package allows a terminal attached to any RS-232 or RS-422 adapter to be selected as a console device. The default device is an RS-232 tty attached to the first standard serial port (S1). However, the console device may be changed by editing the `/etc/consdef` file that is provided on Diagnostic Diskette 4. The file format follows:

```
#
# This is the console definition file used to describe the terminal
# device to be used as the console. It is in the form
# attribute=value, one per line. The location is the location code
# seen when listing devices using lsdev. Spaces must not be entered
# around the = sign.
#
# Remove the # signs from the first column of each line to take
# effect. The location must be specified for any attribute in
# this file to be processed.
#
# For example, to define the console device as an rs232 terminal on
# port S1:
#
#connection=rs232
#location=00-00-S1
#speed=9600
#bpc=8
#stops=1
#xon=yes
#parity=non#term=3163
```

To change this file, take the following steps:

1. Enter:

```
cd /tmp
mkdir diag4
cd diag4
```

2. Insert Diagnostic Diskette 4 into the diskette drive.

3. Enter the following:

```
cpio -iuvmdC36 </dev/rfd0
cd etc
```

4. To edit the file, do the following:

- a. Enter `uncompress consdef`.
- b. Edit the `consdef` file to work with your configuration.
- c. Enter `compress consdef`.

5. Enter the following:

```
cd /tmp/diag4
find . -type f -print | cpio -ouvmC36 > /dev/rfd0
```

6. Use the new Diagnostics Diskette 4 with the new configuration.

## Running the Diagnostic Programs from Disk or from a Server

Consider the following when you run the diagnostic programs from a disk:

- The diagnostics cannot be loaded and run from a disk until the AIX operating system has been installed and configured. After the **installp** command is used to install and configure the AIX operating system, all three modes of operation are available.
- The diagnostics cannot be loaded on a system (client) from a server if that system is not set up to IPL from a server over a network. When the system is set up to IPL from a server, the diagnostics are executed in the same manner as they were from disk.
- If the diagnostics were loaded from disk or a server, you must shut down the AIX operating system before powering the system unit off to prevent possible damage to disk data. This is done in one of two ways:
  - If the diagnostic programs were loaded in standalone mode, press the F3 key until `DIAGNOSTIC OPERATING INSTRUCTIONS` displays; press the F3 key again and follow the instructions that are displayed.
  - If the diagnostic programs were loaded in maintenance or concurrent mode, enter the **shutdown -F** command.
- Under some conditions `c31` may appear in the three-digit display, with instructions displayed on attached displays and terminals. Follow the instructions to select a console display or set the key mode switch to Normal and back to Service if you do not have a console display.

## Running the Diagnostic Programs from CD-ROM

To run the diagnostic programs from a CD-ROM drive, do the following:

1. Remove any diskette from the diskette drive.
2. If the CD-ROM drive is externally attached, set the CD-ROM power switch to On.
3. Insert the caddy with the diagnostic disc into the CD-ROM drive.
4. Place the key mode switch to the service position.
5. Set the system unit power switch to On.

Consider the following when you run the diagnostic programs from CD-ROM:

- The diagnostic disc must remain in the CD-ROM drive while the diagnostics are running.
- The diagnostic programs cannot test the CD-ROM drive that they were loaded from.
- The diagnostic programs cannot test the SCSI adapter connected to the CD-ROM drive that they were loaded from.
- The diagnostic programs cannot run from CD-ROM if the system has less than 16 MB of installed memory.

## Running the Diagnostic Programs from the Network

Consider the following when you run the diagnostic programs from a network:

- Diagnostics cannot be loaded and run from the network until the AIX operating system has been installed and configured on the server.
- You system unit must be configured to receive IPL (initial program load) over the network.

To run the diagnostic programs from the network, do the following:

- Enter the **shutdown -F** command to shut down the operating system
- Turn the key mode switch to the Service position.
- Power off the system unit, wait 30 seconds, then power on the system unit.

## Running the Diagnostic Programs with a 5080 Attached

Consider the following when you run the diagnostic programs on a system attached to a 5080 system:

- When the system unit is attached to a 5085 or 5086 system, the `DIAGNOSTIC OPERATING INSTRUCTIONS` do *not* display on the display attached to the 5085 or 5086. See the *5080 Graphics System Installation, Operation, and Problem Determination* manual, order number GA23-2063 for information about operating the combination system.
- At power on, the keyboard belongs to the graphics processor. Keyboard control can be switched to the system within two minutes of turning the system power on by pressing and holding the Alt key and then pressing the Sw Keybd key.

**Attention:** Do not attach the 5085 or 5086 keyboard to the system unit without the special diagnostic cable.

- There is a special diagnostic cable available with the combination system to attach the 5085 or 5086 keyboard directly to the system unit. See the *5080 Graphics System Installation, Operation, and Problem Determination* manual, order number GA23-2063 for information about setting the combination system up.

## Running the Diagnostic Programs from a TTY Terminal

Consider the following when you run diagnostic programs using a tty-type terminal as the console display:

- See the operator manual for your type of tty terminal to find the key sequences you need to respond to the diagnostic programs. For the 3151, refer to the *3151 ASCII Display Station Guide to Operations*, order number GA18-2633. For the 3164, refer to the *3164 ASCII Color Display Station Description*, order number GA18-2617.
- When the diagnostic programs present display information through the S1 port, certain attributes are used. These attributes are set as if the diagnostic programs were using a 3161 display terminal. The following tables list attributes for the 3161 ASCII Display Terminal and for two other ASCII display terminals commonly used with the system.
- If you have a tty terminal other than a 3151, 3161, or 3164 attached to the S1 port, your terminal may have different names for the attributes. Use the attribute descriptions in the following tables to determine the settings for your terminal.

## General Attributes Always Required

The following general attributes are the default settings for the diagnostic programs. Be sure your terminal is set to these attributes.

**Note:** These attributes should be set before the diagnostic programs are loaded.

General Setup Attributes	3151 (models 11, 31, 41) settings	3161/3164 settings	Description
Machine mode	3151	3161 or 3164	The diagnostic programs are set to emulate use of the 3161 ASCII Display Terminal. If your terminal can emulate a 3151, 3161, or 3164 terminal, use the following attribute settings. Otherwise, refer to your operator's manual, compare the following attribute descriptions with those of your terminal, and set your attributes accordingly.
Screen	Normal		Uses the EIA-232 interface protocol.
Row and column	24 x 80		Uses the EIA-232 interface protocol.
Scroll	Jump	Jump	When the last character on the bottom line is entered, the screen moves down one line.
Auto LF	Off	Off	For the On setting, pressing the Return key moves the cursor to the first character position of the next line. For the Off setting, pressing the Return key moves the cursor to the first character position of the current line. The carriage return (CR) and line feed (LF) characters are generated by the New line setting.
CRT saver	Off	10	The 10 setting causes the display screen to go blank if there is no activity for 10 minutes. When the system unit sends data or a key is pressed, the display screen contents are displayed again.
Line wrap	Off	On	The cursor moves to the first character position of the next line in the page after it reaches the last character position of the current line in the page.
Forcing insert	Off		
Tab	Field	Field	The column tab stops are ignored, and the tab operation depends on the field attribute character positions.
Trace		All	Both inbound data (data to the system unit) and outbound data (data from the system unit) to and from the main port can be transferred to the auxiliary port without disturbing communications with the system unit when the Trace key is pressed.

## Additional Communications Attributes

The following communications attributes are for the 3151, 3161, and 3164 terminals.

Communications Setup Attributes	3151 (models 11, 31, 41) settings	3161/3164 settings	Description
Operating mode	Echo	Echo	Data entered from the keyboard on the terminal is sent to the system unit for translation and then sent back to the display screen. Sometimes called conversational mode.
Line speed	9600 bps	9600 bps	Uses the 9600 bits per second (bps) line speed to communicate with the system unit.
Word length (bits)	8	8	Selects eight bits as a data word length (byte).
Parity	No	No	Does not add a parity bit, and is used together with the word length attribute to form the 8-bit data word (byte).
Stop bit	1	1	Places a bit after a data word (byte).
Turnaround character	CR	CR	Selects the carriage return (CR) character as the line turnaround character.
Interface	EIA-232C	EIA-232C	Uses the EIA-232 interface protocol.
Line control	IPRTS	IPRTS	Uses the 'permanent request to send' (IPRTS) signal to communicate with the system unit.
Break signal (ms)	500	500	The terminal sends a 'break signal' to the system unit within 500 ms after the Break key is pressed.
Send null suppress	On		Trailing null characters are not sent to the system unit.
Send null		On	Trailing null characters are sent to the system unit.
Response delay (ms)	100	100	The terminal waits for 100 ms for the system unit to respond.



## Additional Keyboard Attributes

The following keyboard attributes are for the keyboard attached to the 3151, 3161, and 3164 terminals.

Keyboard Setup Attributes	3151 (models 11, 31, 41) settings	3161/3164 settings	Description
Enter	Return	Return	The Enter key functions as the Return key.
Return	New line	New line	The cursor moves to the next line when the Return key is pressed.
New line	CR	CR	The Return key generates the carriage return (CR) and the line feed (LF) characters. The line turnaround occurs after the CR and LF characters are generated.
Send	Page	Page	The contents of the current page are sent to the system unit when the Send key is pressed.
Insert character	Space	Space	A blank character is inserted when the Insert key is pressed.

## Additional Printer Attributes

The following printer attributes are for a printer attached to the 3151, 3161, and 3164 terminals.

Printer Setup Attributes	3151 (models 11, 31, 41) settings	3161/3164 settings	Description
Line speed	9600	9600	Uses 19200 or 9600 bits per second (bps) line speed to communicate with the system unit.
Word length (bits)	8	8	Selects eight bits as a data word length (byte).
Parity	None	No	
Stop bit	1	1	Places a bit after a data word (byte).
Characters	ALL		
Line end		CR-LF	
Print		Viewport	
Print EOL		Off	
Print null		Off	

---

## Diagnostic Modes of Operation

The diagnostics can be run in three modes:

- Maintenance mode allows checking of most system resources.
- Concurrent mode allows the normal system functions to continue while selected resources are being checked.
- Standalone mode allows checking of all the system devices and features.

### Maintenance Mode

Maintenance mode runs the diagnostics using the customer's operating system. This mode requires that all activity on the operating system be stopped so the diagnostics have most of the resources available to check. All of the system resources except the SCSI adapters and the disk drive used for paging can be checked.

Error log analysis is done in maintenance mode when you select the `Problem Determination` option on the `DIAGNOSTIC MODE SELECTION` menu.

The **`shutdown -m`** command is used to stop all activity on the operating system and put the operating system into maintenance mode. Then the **`diag`** command is used to load the diagnostic controller so you can run the diagnostic programs from the menus. After the diagnostic controller is loaded, follow the normal diagnostic instructions.

### Running the Diagnostics in Maintenance Mode

To run the diagnostics in maintenance mode you must be logged on to the customer's operating system as `root` or `superuser` and use the **`shutdown -m`** and **`diag`** commands. Use the following steps to run the diagnostics in maintenance mode:

1. Stop all programs except the operating system.
2. Log onto the operating system as `root` or `superuser`.
3. Enter the **`shutdown -m`** command.
4. When a message indicates the system is in maintenance mode, enter the **`diag`** command.

**Note:** It may be necessary to set `TERM` type again.

5. When `DIAGNOSTIC OPERATING INSTRUCTIONS` is displayed, follow the displayed instructions to checkout the desired resources.
6. When testing is complete; use the F3 key to return to `DIAGNOSTIC OPERATING INSTRUCTIONS`. Then press the F3 key again to return to the operating system prompt.
7. Press `Ctrl-D` to log off from `root` or `superuser`.

## Concurrent Mode

Concurrent mode provides a way to run diagnostics on some of the system resources while the system is running normal system activity.

Because the system is running in normal operation, some of the resources cannot be tested in concurrent mode. The following resources *cannot* be tested in concurrent mode:

- SCSI adapters connected to paging devices
- The disk drive used for paging
- Some display adapters.

There are three levels of testing in concurrent mode:

- *Share-test level*: Tests a resource while the resource is being shared by programs running in the normal operation. This testing is mostly limited to normal commands that test for the presence of a device or adapter.
- *Sub-test level*: Tests a portion of a resource while the remaining part of the resource is being used in normal operation. For example, this test could test one port of a multiport device while the other ports are being used in normal operation.
- *Full-test level*: Requires the device not be assigned to or used by any other operation. This level of testing on a disk drive may require the use of the **varyoff** command. The diagnostics will display menus to allow you to vary off the needed resource.

The diagnostics also display a menu to assign a resource if another resource is needed.

Error log analysis is done in concurrent mode when you select the `Problem Determination` option on the DIAGNOSTIC MODE SELECTION menu.

To run the diagnostics in concurrent mode you must be logged onto the operating system and have proper authority to issue the commands.

The **diag** command loads the diagnostic controller and displays the diagnostic menus.

## Running the Diagnostics in Concurrent Mode

To run diagnostics in concurrent mode, take the following steps:

1. Log on to the operating system as `root` or `superuser`.
2. Enter the **diag** command.
3. When the `DIAGNOSTIC OPERATING INSTRUCTIONS` are displayed, follow the instructions to check out the desired resources.
4. When testing is complete, use the F3 key to return to the `DIAGNOSTIC OPERATING INSTRUCTIONS`. Then press the F3 key again to return to the operating system prompt. Be sure to vary on any disk drives you had varied to off.
5. Press the Ctrl-D key sequence to log off from `root` or `superuser`.

## Standalone Mode

Standalone mode provides the most complete checkout of the system resources. This mode also requires that no other programs be running on the system.

Standalone mode can be loaded in three ways:

- From diskettes or other removable load media. This method is the only method available for those systems that do not have the operating system installed.
- From a disk within the system unit. This loads the diagnostic programs that are a part of the operating system. The operating system must be installed and configured before the diagnostics can run from it.
- On some system units, built-in diagnostics can be run from read-only memory (ROM). These diagnostics are intended to be used when it is not possible to use the operating system diagnostic programs. The tests provided by the built-in diagnostic programs are not as complete as the operating system diagnostic programs.

## Running the Diagnostics in Standalone Mode

To run diagnostics in standalone mode, take the following steps:

1. Stop all programs including the operating system.
2. Set the power switch on the system unit to Off.
3. Set the key mode switch to the Service position.

**Note:** When the diagnostic programs are run from diskettes or from a CD-ROM disc, the diagnostics do *not* check the error log entries.

4. If you want to load the standalone diagnostics from diskettes, insert the first diagnostic diskette into the diskette drive.
5. If you want to load the standalone diagnostics from a CD-ROM disc, insert the CD-ROM diagnostic disc into the CD-ROM drive.
6. If you want to load the diagnostics from the fixed disk, leave the diskette and CD-ROM drives empty.
7. Set the power switch on the system unit to On.
  - If `c07` is displayed, insert the appropriate diagnostic diskette. If necessary, refer to the CERADME file for additional information.
  - If `c31` is displayed, follow the instructions to select a console display. If your system does not have a console, the diagnostics can be run without a console. To run the diagnostics without a console, wait for `c31` to be displayed, set the key mode switch to the Normal position and then back to the Service position.

When running diagnostics without a console, note the following:

- A `c99` will be displayed at the successful conclusion of testing from disk-based and CD-ROM disc-based diagnostics.
- A `c07` will be displayed at the successful conclusion of testing from the diskette package. Only those devices supported by the diskette just loaded were tested. To test additional devices, load the diskette supporting those devices when `c07` is displayed.
- If the diagnostics detect a problem, a flashing 888 displays in the three-digit display. See “Reading Flashing 888 Numbers” on page 3-14 for instructions on reading the message.

8. After the diagnostic controller loads, `DIAGNOSTIC OPERATING INSTRUCTIONS` appear on the console display.
9. If a problem is detected while the diagnostics are loading, a flashing 888 displays in the three-digit display. See "Reading Flashing 888 Numbers" on page 3-14 for instructions on reading the message.
10. Follow the displayed instructions to checkout the desired resources.
11. When testing is complete, use the F3 key to return to the `DIAGNOSTIC OPERATING INSTRUCTIONS`.
12. If you loaded the diagnostics from the disk, press the F3 key to shut down the diagnostics before turning off the system unit.  
  
If you loaded the diagnostics from diskettes or from a CD-ROM disc, turn off the system unit.

## System Exerciser

The System Exerciser tests and exercises devices in an overlap mode and can only be run from disk in standalone or maintenance mode.

### Starting the System Exerciser

When the System Exerciser is selected from the `FUNCTION SELECTION` menu, another menu displays all devices to be tested. Pressing the Enter key starts tests for all of the devices.

The time required to test all of the devices depends on the number of devices to be tested and can range from several minutes to approximately one hour for a fully loaded system. Because some devices require less time to test than others, the number of times a device is tested under the System Exerciser may be one or more.

**Note:** If the system contains tape devices, CD-ROM, or diskette drives, you will be asked whether you want to use media in the devices when you are testing.

### Display Screens

If the console is a graphics display, normal test patterns are displayed during the tests. After the graphics adapter test is finished, the standby screen is displayed.

If the console is an async terminal, the standby screen will be displayed during testing. The time-of-day will be displayed at the top of the screen and is updated approximately every minute.

After all devices have been tested at least once, a results screen will be displayed until either the Enter key is pressed to restart the System Exerciser or the System Exerciser is stopped. If no errors were detected, the results screen displays the `No trouble found` message; if errors have been detected, the results screen displays a list of devices with corresponding errors.

### Stopping the System Exerciser

Although the System Exerciser can be stopped at any time, it is best to stop it while the results screen is displayed. Stopping the System Exerciser at other times can cause the loss of test information.

When the System Exerciser is stopped, the screen displays all tested devices with errors flagged. Selecting a device that has an error flag provides details such as SRN, location code, number of times the device was tested, and the number of times an error was detected.

## Using the System Exerciser to Check Repairs and Intermittent Problems

The System Exerciser can be used to check the system following repairs and to identify intermittent problems.

When the System Exerciser is running, most built-in error recovery procedures are turned off. This can cause occasional errors to be reported that normally have no effect on system operation. Parts should only be replaced when:

- A high number of errors are reported in relation to the number of times the device was tested.
- Errors reported by the System Exerciser are in the same area as that reported by the customer.

---

## Reading Flashing 888 Numbers

A flashing 888 number indicates that a hardware or software error has occurred and a diagnostic message is ready to be read.

The diagnostic programs display a flashing 888 to indicate a crash message or a diagnostic message is ready to be read.

Use the following procedure to read out a flashing 888 message.

---

### Step 1. Determine the Type of Message

The three-digit display should be flashing 888 .

1. Get a "Problem Report Form" from the *Problem Solving Guide and Reference* or a blank sheet of paper to record the numbers from in the three-digit display.
2. Be sure the mode switch is set to Normal or Service.

**Note:** Every time you press the Reset button, hold it for about one second to allow the program to sense the change.

3. Press the Reset button once. Record the number in the three-digit display. This is the message type.
4. Go to the step listed for your message type:

**Type 102**      Go to Step 2.

**Type 103**      Go to Step 3.

**Type 105**      Go to Step 4.

**Other**         Go to Step 5.

---

## Step 2. Reading the Type 102 Message

Use the following steps and information to determine the content of the type 102 message. See Appendix B for a description of the crash code and dump status.

102 = Message type  
RRR = Crash code  
SSS = Dump status code  
888 or 103 or 105

1. Press the Reset button once and record the crash code.
2. Press the Reset button again and record the dump status code.
3. Press the Reset button again. Look at the number in the three-digit display to answer the following question.

### Is 888 flashing in the three-digit display?

**NO** The message has a type 103 or type 105 message included in it. Go to Step 3 to read out the SRN and FRU information about Type 103 messages. Go to Step 4 to read out the SRN and FRU information about Type 105 messages.

**YES** This completes the read out of this message. You can repeat the message by pressing the Reset button. You must turn off the system unit to recover from this halt.

**Note:** There are no SRNs associated with this message type. If the crash code is 558 and you were loading the diagnostic diskettes, you might have used the wrong diagnostic boot diskette. Try using the boot diskette for 8MB systems.

---

## Step 3. Reading the Type 103 Message

Use the following steps and information to determine the content of the type 103 message (You may have come here from a type 102 message. If so, use the same procedure).

1. Press the Reset button and record the first three digits of the six-digit SRN.

**Note:** The 9333 subsystem displays four-digit SRNs, which are not listed in this book. To decode these SRNs, refer to 9333 subsystem documentation.

2. Press the Reset button and record the second three digits of the six-digit SRN.
3. Each time the Reset button is pressed, three digits of a FRU location code display. When all FRU location codes are read out, the three-digit display returns to the flashing 888 or, if another Type 103 message is waiting to be displayed, a *ccc*. If *ccc* is displayed, repeat this step to receive the next message. Try the first SRN listed; if it does not resolve the problem, try following SRNs in the order listed. If the message contains more than four FRUs, not all FRU location codes will be present.

Press the Reset button and record the three-digit numbers until a flashing 888 displays. Use the following to identify the numbers being read.

103 = Message type

XXX-XXX = SRN

c01 1xx 2xx 3xx 4xx 5xx 6xx 7xx 8xx = First FRU location code

c02 1xx 2xx 3xx 4xx 5xx 6xx 7xx 8xx = Second FRU location code

c03 1xx 2xx 3xx 4xx 5xx 6xx 7xx 8xx = Third FRU location code

c04 1xx 2xx 3xx 4xx 5xx 6xx 7xx 8xx = Fourth FRU location code.

4. Identify the SRN in the message and report the SRN to the service organization. Keep the paper or form you recorded all of the numbers on for the service representative. You can cycle through the numbers again by pressing the Reset button.



5. The FRU location codes translate into an eight-digit location code (AB-CD-EF-GH). Each digit of the eight-digit location code is presented as a three-digit number in the three-digit display.

	A	B	C	D	E	F	G	H	=	Eight-digit location code
c01	1xx	2xx	3xx	4xx	5xx	6xx	7xx	8xx	=	First FRU location code
c02	1xx	2xx	3xx	4xx	5xx	6xx	7xx	8xx	=	Second FRU location code
c03	1xx	2xx	3xx	4xx	5xx	6xx	7xx	8xx	=	Third FRU location code
c04	1xx	2xx	3xx	4xx	5xx	6xx	7xx	8xx	=	Fourth FRU location code .

To identify each digit of the location code (AB-CD-EF-GH), translate the right-most two digits of each position within the encoded SRN using the following table. See "Location Codes" on page 1-5 to determine the physical location of the resource.

**Note:** If `ccx` (x can be any digit from 2 through 9) is encountered as part of the location code, only the part of the code that is different from the location code of the previous FRU is shown. To form the complete location code of the next FRU, substitute the information following the `ccx` into the location code of the previous FRU.

For example, if the previous FRU location is:  
 c01 100 200 300 401 500 601 700 800,  
 and the next FRU location is listed as:  
 cc2 602  
 the complete location code of the next FRU is:  
 cc2 100 200 300 401 500 602 700 800.

xx	Value	xx	Value	xx	Value	xx	Value
00	= 0	11	= A	21	= K	31	= U
01	= 1	12	= B	22	= L	32	= V
02	= 2	13	= C	23	= M	33	= W
03	= 3	14	= D	24	= N	34	= X
04	= 4	15	= E	25	= O	35	= Y
05	= 5	16	= F	26	= P	36	= Z
06	= 6	17	= G	27	= Q		
07	= 7	18	= H	28	= R		
08	= 8	19	= I	29	= S		
09	= 9	20	= J	30	= T		

6. The only way to recover from an 888 type of halt is to turn off the system unit.

---

## Step 4. Reading the Type 105 Message

Use the following steps and information to determine the content of the type 105 message. (You may have come here from a type 102 message. If so, use the same procedure.)

1. Press the Reset button and record the first three digits of the SRN.
2. Press the Reset button and record the next three digits of the six-digit SRN.
3. Repeatedly press the Reset button, each time recording the numbers in the three-digit display, until c01 is displayed.
4. Each time the Reset button is pressed, three digits of a FRU location code display. When all FRU location codes are read out, the three-digit display returns to the flashing 888 or, if another message is waiting to be displayed, a ccc. If ccc is displayed, repeat this step to receive the next message. Try the first SRN listed; if it does not resolve the problem, try following SRNs in the order listed. If the message contains more than four FRUs, not all FRU location codes will be present.

Press the Reset button and record the three-digit numbers until a flashing 888 displays. Use the following to identify the numbers being read.

105 = Message type  
1xx 2xx 3xx 4xx = encoded SRN

c01 1xx 2xx 3xx 4xx 5xx 6xx 7xx 8xx = First FRU location code  
c02 1xx 2xx 3xx 4xx 5xx 6xx 7xx 8xx = Second FRU location code  
c03 1xx 2xx 3xx 4xx 5xx 6xx 7xx 8xx = Third FRU location code  
c04 1xx 2xx 3xx 4xx 5xx 6xx 7xx 8xx = Fourth FRU location code.

5. Determine the SRN by translating the right-most two digits of each position within the encoded SRN (1xx 2xx 3xx 4xx) using the table on page 3-19. Report the SRN to the service organization. Keep the paper or form on which you recorded all of the numbers for the service representative. You can cycle through the numbers again by pressing the Reset button.

6. The FRU location codes translate into an eight-digit location code (AB-CD-EF-GH). Each digit of the eight-digit location code is presented as a three-digit number in the three-digit display.

A B C D E F G H = Eight-digit location code  
 c01 1xx 2xx 3xx 4xx 5xx 6xx 7xx 8xx = First FRU location code  
 c02 1xx 2xx 3xx 4xx 5xx 6xx 7xx 8xx = Second FRU location code  
 c03 1xx 2xx 3xx 4xx 5xx 6xx 7xx 8xx = Third FRU location code  
 c04 1xx 2xx 3xx 4xx 5xx 6xx 7xx 8xx = Fourth FRU location code.

To identify each digit of the location code (AB-CD-EF-GH), translate the right-most two digits of each position within the encoded SRN using the following table. See "Location Codes" on page 1-5 to determine the physical location of the resource.

**Note:** If ccx (x can be any digit from 2 through 9) is encountered as part of the location code, only the part of the code that is different from the location code of the previous FRU is shown. To form the complete location code of the next FRU, substitute the information following the ccx into the location code of the previous FRU.

For example, if the previous FRU location is:  
 c01 100 200 300 401 500 601 700 800,  
 and the next FRU location is listed as:  
 cc2 602  
 the complete location code of the next FRU is:  
 cc2 100 200 300 401 500 602 700 800.

xx	Value	xx	Value	xx	Value	xx	Value
00	= 0	11	= A	21	= K	31	= U
01	= 1	12	= B	22	= L	32	= V
02	= 2	13	= C	23	= M	33	= W
03	= 3	14	= D	24	= N	34	= X
04	= 4	15	= E	25	= O	35	= Y
05	= 5	16	= F	26	= P	36	= Z
06	= 6	17	= G	27	= Q		
07	= 7	18	= H	28	= R		
08	= 8	19	= I	29	= S		
09	= 9	20	= J	30	= T		

7. The only way to recover from an 888 type of halt is to turn off the system unit.

---

## Step 5. Other Numbers

If the message type is a type 104, it contains information that is not used by the service organization. Disregard this information. If you have another number displayed for the message type, do the following:

1. Press the Reset button again and again until a flashing 888 is displayed in the three-digit display. If you do not get a flashing 888 in the display, you should consider the numbers as *steady* numbers. Go to the *Problem Solving Guide and Reference* and follow the procedures for analyzing three-digit display codes.
2. When the flashing 888 displays, go to Step 1.



---

## Chapter 4. Using the Service Aids

This chapter contains information about using the service aids available in various media formats.

---

### Introduction to Service Aids

The diagnostic programs contain programs called service aids. The service aids are used to display data and do additional testing.

The following service aids are provided:

- Service hints
- Display previous diagnostic results
- Display or change configuration or vital product data
- Display or change diagnostic test list
- Disk media
- Diskette media
- Local area network (LAN)
- SCSI bus
- Display test patterns
- Microcode download
- Product topology
- Display/alter bootlist
- Trace
- Dials and LPFK configuration
- Diagnostic diskette creation
- Disk-based diagnostic update
- Hardware error report
- Display test patterns for the multimedia video capture adapter

These service aids are described in the following topics.

---

### Service Hints

The Service Hints service aid reads and displays the information in the CEREADME file from the diagnostics source (diskettes, disk, or CD-ROM). This file contains information that is not in the publications for this version of the diagnostics. It also contains information about using this particular version of diagnostics.

Use the Enter key to page forward through the information or the – (dash) and Enter keys to page backward through the file.

---

## Display Previous Diagnostic Results

**Note:** This service aid is not available when you load the diagnostics from a source other than a disk drive or from a network.

Each time the diagnostics produce a service request number (SRN) to report a problem, information about that problem is logged. The service representative can look at this log to see which SRNs are recorded. This log also records the results of diagnostic tests that are run in loop mode.

When this service aid is selected, information on the last problem logged is displayed. The Page Down and Page Up keys can be used to look at information about previous problems.

This information is *not* from the error log maintained by the AIX operating system. This information is stored in the `/etc/lpp/diagnostics/data/*.dat` file.

---

## Display or Change Configuration or Vital Product Data (VPD)

**Note:** The following AIX operating system commands are not available for use when you load this service aid from diskettes.

This service aid allows you to display and change configuration data and vital product data (VPD).

Use the `lscfg` command to copy the contents of the configuration and VPD files to another file or to a printer. This command identifies the resources that have diagnostic support. For more information about the `lscfg` command, see the AIX operating system information.

In the following examples, the first example copies the configuration data and VPD to a file named `/u/mine/VPD`. The second example prints the configuration list. The third example displays the VPD on the screen.

```
lscfg -v > /u/mine/VPD
lscfg | enq
lscfg -v | pg
```

### Display Configuration

This service aid displays a list of the resources installed on this system.

### Display Vital Product Data

This service aid displays the VPD for all of the resources installed on this system. Use the Page Down and Page Up keys to see the data for all resources.

### Display/Alter Vital Product Data

**Attention:** If this service aid was loaded from a source other than the disk drive or network, any changes or additions you make to the VPD data will be lost when you set the power switch to Off.

This service aid allows you to display and alter the VPD for any resource. When you select this service aid, a menu allows you to select the desired resource.

## Change Configuration

**Attention:** If this service aid was loaded from a source other than the disk drive or network, any changes or additions you make to the VPD data will be lost when you set the power switch to Off.

This service aid allows you to add or delete data for the drawer data from the configuration list. This service aid is used to add nonmachine-readable data to the configuration list.

---

## Display or Change Diagnostic Test List

During power-on self-test (POST), the diagnostic controller uses the diagnostic test list to determine which resources to check.

This service aid provides a way to delete a resource from the diagnostic test list and a way to add a deleted resource back into the diagnostic test list. This service aid also provides a way to display the diagnostic test list.

---

## Disk Media

This service aid provides a Format Disk service aid and a Certify Disk service aid.

### Format Disk

There are two options available to format a disk, and an option that can be used to overwrite all accessible blocks on the disk with a user-selectable pattern.

### Format without Certify

The format option writes all of the ID fields and writes a bit pattern in all of the data fields. This option does *not* reassign data blocks that are bad.

### Format and Certify

The format and certify option writes all of the ID fields and writes a bit pattern in all of the data fields. It also reassigns any data blocks found to be bad during formatting. If there are too many bad data blocks, a message is sent to alert you.

This service aid should be used to completely erase the existing data on a disk. The diagnostic programs may instruct you to use this service aid when data on a disk is found to be badly damaged.

### Erase Disk

This option can be used to overwrite (remove) all data currently stored in user-accessible blocks of the disk. The Erase Disk option writes one or more patterns to the disk. An additional option allows data in a selectable block to be read and displayed on the system console.

To use the Erase Disk option, specify the number (0–3) of patterns to be written. Select the patterns to be written; the patterns are written serially. That is, the first pattern is written to all blocks. Then the next pattern is written to all blocks, overlaying the previous pattern. A random pattern will be written by selecting the “Write random pattern?” option.

### Certify Disk

The Certify Disk service aid reads all of the ID and data fields. It checks for bad data in the ID and data fields. If there are too many bad data blocks, a message is sent to alert you.

---

## Diskette Media

This service aid provides a way to verify the data written on a diskette. When this service aid is selected, a menu asks you to select the type of diskette being verified. The program then reads all of the ID and data fields on the diskette one time and displays the total number of bad sectors found.

---

## Local Area Network

This service aid provides a means to analyze local area network (LAN) problems related to attached Ethernet, Token-Ring, and FDDI adapters. The service aid allows you to do the following:

- Monitor the ring (Token-Ring only). Abnormal conditions are reported.
- Test connectivity. Data is transferred between two stations, and the results are reported.

---

## SCSI Bus

This service aid provides additional testing for SCSI bus problems and should be used only after the normal diagnostic test programs do not find a problem.

A **SCSI Inquiry** command is sent to a SCSI device you select from the SCSI BUS ADDRESS SELECTION menu; test results are then displayed. To analyze a SCSI bus problem, start with only one device attached; then add one device at a time until you identify the failing device. *Always* use a terminator at the end of the SCSI bus.

---

## Display Test Patterns

**Note:** This service aid should not be run in a multiwindow environment.

This service aid provides a way to display the test patterns needed to adjust the 5081, 6091, and 8517 displays. Select the pattern you need from the menu.

---

## Microcode Download

Microcode Download is a service aid that allows microcode resident on devices such as disk or tape drives to be updated. This service is normally needed when a problem is discovered or an enhancement is made to existing microcode.

This service aid presents you with a list of the drives that use microcode. Select the type drive on which you are installing the code, and follow the displayed instructions.



---

## Product Topology

The Product Topology Data System has been created to enhance product and order quality within this system family.

### Introduction

The Product Topology Data System records and maintains the following data:

- Machine configuration, including both Feature Code and Manufacturing Feature Bill of Material nomenclature
- Machine contents, including part numbers and EC levels
- History of actions taken with machine hardware.

Data collection and recording for a machine begins with the initial order and continues through the manufacturing process into field service. This physical history, combined with the current configuration, is a valuable resource in managing product quality. Additionally, current machine configurations as reported from the field through Update Diskettes are used as a database for developing and improving Miscellaneous Engineering Specification (MES) upgrade orders and their installability.

The entire process supports a Market Driven Quality focus.

### Service Aid Operation

The machines leave the plant of manufacture with a Product Topology System Diskette, which contains the latest version of this service aid.

This service aid can be executed in one of the following ways:

- By following the instructions that accompanied the Product Topology System Diskette included with the machine or included with the MES shipment from the plant of manufacture (the preferred method).
- By executing the Product Topology service aid from the operating system-based diagnostics on the disk drive.
- By executing the standalone diskette-based or CD-ROM disc-based diagnostics for machines that do not have, or do not plan to have, the operating system installed.

This service aid can be executed concurrently with other operating system applications; it is not necessary to remove the machine from normal operating service to run the program. In the case of a disk drive failure, or when the standalone diskette diagnostics package or the diagnostic CD-ROM disc is used, the Product Topology service aid should be run from the disk drive *after* the machine is restored to normal operation.

## Initial Installation

The first time the Product Topology service aid is executed, or after having re-installed the operating system, you will be prompted to supply information on a screen that is similar to the following.

PRODUCT TOPOLOGY SYSTEM RECORD	802601
The following information lists the current system record data. Any data in brackets [] may be changed or added at this time. Menu items with an asterisk (*) require a valid data entry.	
* Machine serial number . . . . . ie. 2612345 . . . . .	[]
* Machine type . . . . . ie. 7015 . . . . .	[]
Machine model . . . . . ie. 98F . . . . .	[]
* Name (may be individual or company) . . . . .	[]
* Address( number and street) . . . . .	[]
* Address (city and state) . . . . .	[]
Address (zip) . . . . .	[]
Contact Name . . . . .	[]
Contact Phone . . . . . ie. 512-555-1212 . . . . .	[]
System number . . . . . ie. 0000HBF . . . . .	[]
Customer number . . . . . ie. 1234567 . . . . .	[]
Electronic address . . . . .	[]
F1=Help	F2=Refresh
F3=Cancel	F4=List
F5=Undo	F7=Commit
F10=Exit	

### Notes:

1. The serial number and machine type can be found on a label on the front or top of your system unit.
2. The model number can be found on the product logo on the front panel of the system unit.

## Identify the Location of SCSI Devices

You will next be asked to identify the location of all detected SCSI devices (either 'Internal' or 'External'), using a screen that is similar to the following.

PRODUCT TOPOLOGY SCSI DEVICE LOCATION		802603
A new SCSI device was detected that is not in the Product Topology Data. Please enter the SCSI device location ('IN' for internal, 'EX' for external) for the following device:		
Title .....	857 MB SCSI Disk Drive	
Part Number .....		
Part Location .....	00-00-0S-00	
Resource Name .....	hdisk0	
EC Level .....		
Serial Number .....	00003453	
Displayable Message .....		
When finished, or when no further information is available, use 'Commit' to accept the data.		
SCSI Device Location (Internal or External)...	??	+
F1=Help	F2=Refresh	
F3=Cancel	F4=List	
F5=Undo	F7=Commit	
F10=Exit		

**Note:** This screen will appear for each SCSI device on your system that has not had a location determined for it.

## Subsequent Executions

After the initial execution of this service aid, subsequent executions will allow you to verify or modify any of the previously entered information.

**Note:** Always be sure to verify that the Machine Type and Machine Model are correct for your machine. These values may need to change if your machine is upgraded to a new or different model.

## Completing the Product Topology Process

The final step of the product topology process is to write an Update Diskette which is returned to the plant of manufacture. When you see the following screen, follow the instructions carefully.

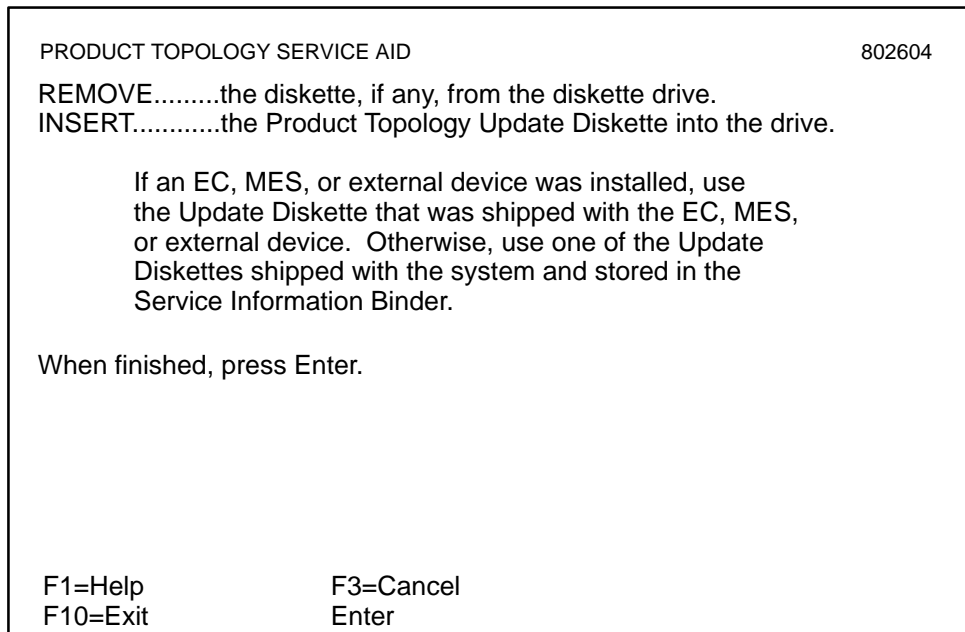

When the diskette-writing procedure is finished, the Product Topology Service Aid menu automatically returns to the screen.

**Note:** Do not remove a diskette from the drive until:

- The diskette drive light has turned off.
- Prompted to do so by the software.
- The Product Topology Service Aid procedure terminates, and the Product Topology Service Aid menu is displayed.

## Older Versions of the Service Aid

If you are running an older version of the Product Topology Service Aid, you will see screens that are different from the ones shown here. Either upgrade your version of this service aid to the latest level (using the diskette and instructions that came with your machine or MES), or contact the support center for assistance.

## Machines without Product Topology

Some disk drive machines do not have product topology data installed because the Product Topology service aid has not been run from disk. When the Product Topology service aid is run from the diskette diagnostics package or from the diagnostic CD-ROM disc, the system does not record product topology data onto the disk drive. When the Product Topology service aid is eventually run from the disk drive following an MES installation or repair action, the program will ask you to provide all of the machine-specific information in the same manner as is done for an Initial Installation.

---

## Display/Alter Bootlist

This service aid allows you to display, alter, or erase the list of the IPL devices from which the system will attempt to load either the AIX operating system or the diagnostic programs.

The system will attempt to perform an IPL from the first device in the list. If the device is not a valid IPL device or if the IPL fails, the system will proceed in turn to the other devices in the list to attempt an IPL.

---

## Trace

The Trace service aid is used as a tool to correct problems with microcode on either a serial disk adapter or a serial disk controller. This service aid is intended for use by trained service representatives.

---

## Dials and LPFK Configuration

This service aid configures Dials or lighted programmable function keys (LPFK) devices to be used on the S1 or S2 serial port. Until these devices are configured, they cannot be tested by the diagnostic programs. If Dials or LPFK devices attached to the S1 or S2 serial port do not appear on the diagnostic test list, use this service aid first to configure the device.

---

## Diagnostic Diskette Creation

### Notes:

1. Before creating diagnostic diskettes with this service aid, any service update software (PTFs) should be applied first.
2. This service aid is not supported on version 4.1 or later of the diagnostic package.

The Diagnostic Diskette Creation service aid requires at least 10,000 blocks of free space in the **root** directory and 8800 blocks of free space in the **/tmp** directory. If you do not have enough free space in these directories, an error message displays when you run this service aid.

**Note:** If you receive any messages about missing files when you run this service aid, the diskettes created by this service aid may not work properly. The files identified by the messages may be necessary for these diskettes to work properly.

This service aid creates diagnostic diskettes that are customized to the system they were created on. The diskettes created by this service aid contain only the diagnostics for the devices on the system the service aid is run on.

---

## Disk-Based Diagnostic Update

This service aid is used to update to the most current level, the diagnostic programs stored on the disk. The update is performed by inserting all diskettes containing the service update software (PTFs) into the diskette drive when the service aid prompts you to do so.

---

## Hardware Error Report

This service aid provides a tool for viewing the system error log for hardware errors.

The service aid will display information concerning error log entries classified as hardware errors. This service aid scans the error log for hardware type errors and then displays the data to the user. The service aid has the option to format some error log entry types making them more meaningful to the user.

---

## Display Test Patterns for the Multimedia Video Capture Adapter

**Note:** This service aid is not available on AIX diagnostics version 4.1 or later.

The Multimedia Video Capture Adapter service aid provides a selection of patterns to be used for adjusting the multimedia video capture adapter. Select the appropriate pattern from the choices listed on the Multimedia Video Service Aid menu.

---

## Chapter 5. Using the System Verification Procedure

This chapter contains information about pre-procedure considerations and running the system verification.

---

### System Verification Procedure

The system verification procedure is used to check the system for correct operation.

When you are analyzing a hardware problem, you should use the “Hardware Problem Determination Procedure” on page 6-1.

---

### Step 1. Considerations before Running This Procedure

#### Notes:

1. If this system unit is directly attached to another system unit or attached to a network, be sure communications with the other system unit is stopped. If needed, see Chapter 2 for more information about multiple system attachments.
2. This procedure requires use of all of the system resources. No other activity can be running on the system while you are doing this procedure.

- This procedure requires a direct-attached display or a tty terminal attached to the S1 port.
- Before starting this procedure, you should stop all programs and the operating system.
- This procedure runs the diagnostic programs in standalone mode from either a disk, diskette, or CD-ROM disc. If the diagnostic programs are installed on disk, these procedures should be run from disk. See the operator manual for your type tty terminal to find the key sequences you need to respond to the diagnostic programs.

If you need more information about standalone mode, see “Diagnostic Modes of Operation” on page 3-10.

- If a console display is not selected, the diagnostics stop with `c31` in the three-digit display. The instructions for selecting a console display are displayed on all of the direct-attached displays and any terminal attached to the S1 port. Follow the displayed instructions to select a console display.
- If the system unit is attached to a 5085 or 5086, the DIAGNOSTIC OPERATING INSTRUCTIONS menu does *not* display on the display attached to the 5085 or 5086.
- Go to Step 2.

---

## Step 2. Loading the Diagnostic Programs

1. Stop all application programs running on the operating system.
2. Stop the operating system (get help if needed).
3. Set the power switch on the system unit to Off.
4. Set the key mode switch to the Service position.
5. If you are loading the diagnostics from diskettes or a CD-ROM drive and running them from a tty terminal:
  - The tty terminal must be attached to the S1 port on the system unit.
  - The attributes for the terminal must be set to match the defaults of the diagnostic programs.
  - If you need to change any settings, record the normal settings, and be sure the terminal attributes are set to work with the diagnostic programs. If needed, see “Running the Diagnostic Programs from a TTY Terminal” on page 3-6.
  - Return to substep 6 when you finish checking the attributes.
6. Set the power switch on the system unit to On.
  - If `c07` is displayed, insert the next diagnostic diskette.
  - If `c31` is displayed, select the console display using the displayed instructions.
7. When the `DIAGNOSTIC OPERATING INSTRUCTIONS` display, go to Step 3.

---

## Step 3. Running System Verification

The `DIAGNOSTIC OPERATING INSTRUCTIONS` should be displayed.

1. Press the Enter key.
2. If the terminal type has not been defined, you must use the `Initialize Terminal` option on the `FUNCTION SELECTION` menu to initialize the operating system environment before you can continue with the diagnostics. This is a separate and different operation than selecting the console display.
3. If you want to do a general checkout without much operator action, select the `Diagnostic Routines` option on the `FUNCTION SELECTION` menu.
  - If you want to do a more complete checkout including the use of wrap plugs, select the `Advanced Diagnostics` option on the `FUNCTION SELECTION` menu. The advanced diagnostics are primarily for the service representative; they may instruct you to install wrap plugs to better isolate a problem.
4. Select the `System Verification` option on the `DIAGNOSTIC MODE SELECTION` menu.
5. If you want to run a general checkout of all installed resources, select the `System Checkout` option on the `DIAGNOSTIC SELECTION` menu.
  - If you want to check one particular resource, select that resource on the `DIAGNOSTIC SELECTION` menu.
6. Go to Step 4.



---

## Step 4. Additional System Verification

The checkout programs end with either the TESTING COMPLETE menu and a message stating `No trouble was found` or the `A PROBLEM WAS DETECTED ON (Time stamp)` menu with an SRN.

1. Press Enter to return to the DIAGNOSTIC SELECTION menu.
2. If you want to check other resources, select the resource. When you have checked all of the resources you need to check, go to Step 5.

---

## Step 5. Stopping the Diagnostics

1. If diagnostics are being run from disk, the system first should be shut down using the following procedure:
  - a. Press F3 again and again until you get to the `DIAGNOSTIC OPERATING INSTRUCTIONS`.
  - b. Press F3 then follow the displayed instructions to either shut down the system or to continue using the diagnostic program.
2. Set the key mode switch to the Normal position.
3. If you changed any attributes on your tty terminal to run the diagnostic programs, change the settings back to normal.
4. This completes the system verification. Report the SRN to the service organization if you received one. To do a normal IPL, turn off the system unit and wait 30 seconds; then set the power switch of the system unit to On.



---

## Chapter 6. Hardware Problem Determination

This chapter contains steps for obtaining a service request number (SRN) to correct hardware problems.

---

### Hardware Problem Determination Procedure

This chapter contains steps for obtaining a service request number (SRN). You report the SRN to the service organization. The service organization uses the SRN to determine which field replaceable units (FRUs) are needed to restore the system to correct operation.

---

### Step 1. Considerations before Performing This Procedure

**Note:** See the operator manual for your type tty of terminal to find the key sequences you need to respond to the diagnostic programs.

- The diagnostic programs can use direct-attached displays or a tty terminal attached to the S1 port.
- This procedure asks you to select the mode you want to run the diagnostic programs in (standalone, maintenance, or concurrent). If you need more information about the modes, see “Diagnostic Modes of Operation” on page 3-10.
- If the system unit is attached to a 5085 or 5086, the `DIAGNOSTIC OPERATING INSTRUCTIONS` do *not* display on the display attached to the 5085 or 5086.
- If the procedure instructs you to stop the operating system, refer to Chapter 3 for additional information.
- Go to Step 2.

---

## Step 2

(From Step 1)

The AIX operating system contains the diagnostic programs. Other operating systems may not contain diagnostic programs.

**Is the AIX operating system used on this system?**

**NO**                      Go to Step 21.

**YES**                     Go to Step 3.

---

## Step 3

(From Step 2)

Determine if the AIX operating system is accepting commands.

**Is the AIX operating system accepting commands?**

**NO**                      Try the following:

1. Stop the operating system.
2. If you cannot stop the operating system, set the power switch on the system unit to Off; then go to Step 6.

**YES**                     Go to Step 4.

---

## Step 4

(From Step 3)

Diagnostic tests can be run on many resources while the operating system is running. However, problem isolation is obtained by running diagnostics in standalone mode.

### Do you want to run the diagnostics in standalone mode?

**NO** Go to Step 5.

**YES** Do the following to shut down your system:

1. At the system prompt, stop the operating system.
2. After the operating system is stopped, set the power switch on the system unit to Off.
3. Go to Step 6.

---

## Step 5

(From Step 4)

This step loads concurrent diagnostics.

1. Log on as `root` or as `superuser`.
2. Enter the `diag` command.
3. Wait until the words `DIAGNOSTIC OPERATING INSTRUCTIONS` are displayed, or wait for three minutes.

### Are the `DIAGNOSTIC OPERATING INSTRUCTIONS` displayed without any obvious console display problems?

**NO** Do the following to shut down your system:

1. At the system prompt, stop the operating system.
2. After the operating system is stopped, set the power switch on the system unit to Off.
3. Go to Step 6.

**YES** Go to Step 10.

---

## Step 6

(From Steps 3, 4, 5, 7)

This step loads standalone diagnostics.

1. Set the key mode switch to the Service position.
2. Be sure the power switches of the attached devices are set to On.
3. Set the power switch on the system unit to On.
4. If `c31` is displayed, follow the displayed instructions to select a console display. If you do not have a console display, set the key mode switch to the Normal position and then set it to the Service position to indicate to the diagnostics there is no console display.

If you cannot select a console display, go to Step 20. Otherwise, continue to the next substep.

5. Wait until one of the following conditions occurs, then go to the next substep:
  - The power-on light does not come on, or it comes on and does not stay on.
  - The same number is displayed in the three-digit display for longer than three minutes, and the power-on light is on.
  - The number 888 is flashing in the three-digit display.
  - The three-digit display is blank.
  - The system stops with two or more numbers between 221 and 296 alternating in the three-digit display.
  - The words `DIAGNOSTIC OPERATING INSTRUCTIONS` are displayed.

6. Starting at the top of the following table, find your symptom and follow the instructions given in the Action column.

Symptom	Action
The system stops with a blank three-digit display and the words <code>DIAGNOSTIC OPERATING INSTRUCTIONS</code> are displayed with no obvious problem on the console display (for example, it is not distorted or blurred).	Go to Step 10.
The power-on light does not come on or comes on and does not stay on.	<p>Ensure that the Key Mode Switch is in the Service position.</p> <p>Check the power cable to the outlet.</p> <p>Check the circuit breakers and check for power at the outlet.</p> <p>If you do not find a problem, record SRN 111-152 and report the problem to the service organization.</p> <p><b>STOP.</b> You have completed these procedures.</p>
The system stops with a steady (not flashing) number displayed in the three-digit display, and the power-on light is on.	<p>The number must be other than <code>c31</code>. See substep 4 for this number.</p> <p>Go to Step 7.</p>
The system stops with <code>888</code> flashing in the three-digit display.	Go to Step 8.
The system stops with a blank three-digit display, and the words <code>DIAGNOSTIC OPERATING INSTRUCTIONS</code> are <i>not</i> displayed correctly.	Go to Step 9.
The three-digit display is blank and the normal system login screen is displayed.	<p>Be sure the key mode switch is set to the Service position.</p> <p>If the key mode switch was not in the Service position, stop the operating system, set it to the Service position, and press Reset. Then repeat this step.</p> <p>If the key mode switch was in the Service position, record and report SRN 111-102.</p> <p><b>STOP.</b> You have completed these procedures.</p>
The system stops with two or more numbers between <code>221</code> and <code>296</code> alternating in the three-digit display.	Go to Step 16.

---

## Step 7

(From Steps 6, 18)

The following steps analyze a steady (not flashing) number displayed in the three-digit display while attempting to load the diagnostics.

Three-Digit Display Number	Action
200	<p>Be sure the key mode switch is set to the Service position.</p> <p>If the key mode switch was not in the Service position, set it to the Service position, and then go to Step 6, substep 4.</p> <p>If the key mode switch was in the Service position, record and report SRN 111-200.</p> <p><b>STOP.</b> You have completed these procedures.</p>
Any other number	<p>Record and report SRN 101-xxx (where xxx is the number displayed in the three-digit display).</p> <p><b>STOP.</b> You have completed these procedures.</p>

---

## Step 8

(From Steps 6, 18)

A flashing 888 in the three-digit display indicates that a crash message or a diagnostic message is ready to be read.

1. Use the steps in "Reading Flashing 888 Numbers" on page 3-14 to:
  - Read all of the message.
  - Identify the SRN if applicable.
  - Record the remaining numbers for the service representative.
2. If you identified an SRN, go to substep 3. Otherwise, go to substep 5.
3. Record the SRN and any other numbers.
4. Report the SRN to the service organization. Report any other numbers read to the service representative to determine the location of the failing FRU.
5. **STOP.** You have completed these procedures.



---

## Step 9

(From Steps 6, 18, 20)

The following steps analyze a console display problem.

Find your type of console display in the following table; then follow the instructions given in the Action column.

Console Display	Action
Display Device	Go to the your display documentation for problem determination.
tty terminal	Go to the documentation for problem determination for this type of terminal.

---

## Step 10

(From Steps 5, 6, 12, 18)

The diagnostic control program loaded correctly.

Press the Enter key.

**Is the FUNCTION SELECTION menu displayed?**

**NO**            Go to Step 11.

**YES**            Go to Step 12.

---

## Step 11

(From Steps 10, 12, 20)

There is a problem with the keyboard.

Find the type of keyboard you are using in the following table; then follow the instructions given in the Action column.

Keyboard Type	Action
101-key keyboard. Identify by the type of Enter key used. The Enter key is within one horizontal row of keys.	Record and report service request number 111-921. <b>STOP.</b> You have completed these procedures.
102-key keyboard. Identify by the type of Enter key used. The Enter key extends into two horizontal rows of keys.	Record and report service request number 111-922. <b>STOP.</b> You have completed these procedures.
Kanji keyboard. Identify by the Japanese characters.	Record and report service request number 111-923. <b>STOP.</b> You have completed these procedures.
tty-terminal keyboard. This applies to all attached terminals.	Go to the documentation for problem determination for this type terminal.

---

## Step 12

(From Step 10)

1. If the terminal type has not been defined, you must use the `Initialize Terminal` option on the `FUNCTION SELECTION` menu to initialize the operating system environment before you can continue with the diagnostics. This is a separate and different operation than selecting the console display.
2. Select `Diagnostic Routines`.
3. Press the Enter key.
4. In the following table, find the menu or system response you received when you selected `Diagnostic Routines`; then follow the instructions given in the Action column.

System Response	Action
The DIAGNOSTIC MODE SELECTION menu is displayed.	Select <code>Problem Determination</code> , and then go to Step 13.
The MISSING RESOURCE menu is displayed.	<p>Follow the displayed instructions until either the DIAGNOSTIC SELECTION menu or an SRN is displayed.</p> <p>If the DIAGNOSTIC SELECTION menu is displayed, go to Step 13.</p> <p>If you get an SRN, record it, and go to Step 15.</p> <p>If you get a number in the three-digit display, go to Step 14.</p>
The NEW RESOURCE menu is displayed.	<p>Follow the displayed instructions.</p> <p>Note: Devices attached to serial ports S1 or S2 will not appear on the NEW RESOURCE menu.</p> <p>If the DIAGNOSTIC SELECTION menu is displayed, go to Step 13.</p> <p>If you get an SRN, record it, and go to Step 15.</p> <p>If you do <i>not</i> get an SRN, go to Step 19.</p>
<p>The diagnostics begin testing a resource.</p> <p><b>Note:</b> If <code>Problem Determination</code> was selected from the DIAGNOSTIC MODE SELECTION menu, and if a recent error has been logged in the error log, the diagnostics will automatically begin testing the resource.</p>	<p>Follow the displayed instructions.</p> <p>If the <code>No Trouble Found</code> screen is displayed, press Enter.</p> <p>If another resource is tested, repeat this step.</p> <p>If the ADVANCED DIAGNOSTIC SELECTION menu is displayed, go to Step 10.</p> <p>If an SRN is displayed, record it, and go to Step 15.</p>

---

## Step 13

(From Step 12)

The system checkout option checks all of the resources (available in standalone mode only).

Select and run the diagnostic tests on the resources you are having problems with or run system checkout to check all of the configured resources. Find the response in the following table and perform the specific action.

Diagnostic Response	Action
An SRN is displayed.	Go to Step 15.
The system stopped with a number displayed in the three-digit display.	Go to Step 14.
The TESTING COMPLETE menu and the No trouble was found message is displayed, and you have <i>not</i> tested all of the resources.	Press Enter and continue with the testing.
The TESTING COMPLETE menu and the No trouble was found message displayed and you have tested <i>all</i> of the resources.	Go to Step 19.  Notes: If Dials and LPFKs are attached to serial ports S1 or S2 and you are running diagnostics from disk or server, the Dials and LPFKs will only appear on the selection screen if they have been configured by the user. Use the Dials and LPFKs Configuration service aid to configure these devices.  If the Dials and LPFKs are attached to serial ports S1 or S2, you must configure them using the Dials and LPFKs Configuration service aid before they can be tested from diskette.

---

## Step 14

(From Steps 12, 13)

A flashing 888 in the three-digit display indicates that a crash message or a diagnostic message is ready to be read.

1. Use the steps in "Reading Flashing 888 Numbers" on page 3-14 to:
  - Read all of the message.
  - Identify the SRN.
  - Record the remaining numbers for the service representative.
2. Record the SRN.
3. Report the SRN to the service organization. Report any other numbers to the service representative to determine the location of the failing FRU.
4. **STOP.** You have completed these procedures.

---

## Step 15

(From Steps 12, 13)

The diagnostic programs produced an SRN for this problem.

1. Record the SRN and any other numbers.
2. Report the SRN to the service organization.
3. **STOP.** You have completed these procedures.

---

## Step 16

(From Step 6)

The system stopped with two or more numbers between 221 and 296 alternating in the three-digit display. This indicates the diagnostics could not load from disk, so the load program is looking for the diagnostic programs on the diskettes or some other load device.

**Are you trying to load the diagnostic programs from diskettes or a CD-ROM disc?**

**NO**                    Go to Step 22.

**YES**                    Record and report SRN 111-101.

**STOP.** You have completed these procedures.

---

## Step 17

(From Steps 21, 22)

When you load the diagnostics from diskettes or a CD-ROM disc and run them from a tty terminal, the attributes for the terminal must be set to match the defaults of the diagnostic programs. The tty terminal must be attached to port S1 on the system unit.

**Are you going to load the diagnostics from diskettes or a CD-ROM disc and run them from a tty terminal attached to port S1?**

**NO**                    Go to Step 18.

**YES**                    Go to "Running the Diagnostic Programs from a tty Terminal" on page 3-6 and be sure your terminal attributes are set to work with the diagnostic programs.

Return to Step 18 when you finish checking the attributes. Record any settings that are changed.

---

## Step 18

(From Step 17)

The following steps analyze a failure to load the diagnostic programs from a disk, or a failure to determine whether the diagnostic programs are on a disk.

1. Set the power switch on the system unit to Off.
2. Set the key mode switch to the Service position.
3. Insert either the first diagnostic diskette into the diskette drive or the diagnostic CD-ROM disc into the CD-ROM drive.
4. Set the power switch on the system unit to On.
5. If `c07` is displayed in the three-digit display, insert the next diagnostic diskette. If `c31` is displayed, follow the displayed instructions to select the console display. If no console display is available, set the key mode switch to the Normal position, and then set it to the Service position to indicate to the diagnostics that there is no console display.

If you cannot select a console display, go to Step 20. Otherwise, continue to the next substep.

6. Wait until one of the following conditions occur, then go to the next substep:
  - The system stops with two or more numbers between 221 and 296 alternating in the three-digit display.
  - The same number is displayed in the three-digit display for longer than three minutes, and the power-on light is on.
  - The number 888 is flashing in the three-digit display.
  - The three-digit display is blank.
  - The words `DIAGNOSTIC OPERATING INSTRUCTIONS` are displayed.

7. Starting at the top of the following table, find your symptom; then perform the specific action.

Symptom	Action
The system stops with a blank three-digit display, and the words DIAGNOSTIC OPERATING INSTRUCTIONS are displayed with no obvious problem on the console display (for example, it is not distorted or blurred).	Go to Step 10.
The system stops with a blank three-digit display, and the words DIAGNOSTIC OPERATING INSTRUCTIONS are <i>not</i> displayed correctly.	Go to Step 9.
The system stops with a steady (not flashing) number displayed in the three-digit display, and the power-on light is on.	The number must be other than c07 or c31. See previous substep 4 for these numbers.  Go to Step 7.
The system stops with 888 flashing in the three-digit display.	Go to Step 8.
The system stops with two or more numbers between 221 and 296 alternating in the three-digit display.	Record and report SRN 111-101.  <b>STOP.</b> You have completed these procedures.

---

## Step 19

(From Steps 12, 13)

The diagnostics did not find a hardware problem. If you still have a problem, contact your software support center. If you are attached to another system, refer to page 2-5 and check your configuration before calling the software support center.

---

## Step 20

(From Steps 6, 18)

**When the c31 halt was present, were the instructions to select a console display readable with no obvious problems with the display?**

**NO**                      Go to Step 9.

**YES**                      Go to Step 11.

---

## Step 21

(From Step 2)

An English-only version of diagnostics are provided on diskette and CD-ROM disc.

**Do you want to run diagnostics from diskette or a CD-ROM disc?**

**NO**                    If you have a problem, call for service, and report the problem.

**YES**                    Go to Step 17.

---

## Step 22

(From Step 16)

An English-only version of diagnostics are provided on diskette and CD-ROM disc.

**Do you want to run diagnostics from diskette or a CD-ROM disc?**

**NO**                    Record and report SRN 111-103. **Stop.** You have completed these procedures.

**YES**                    Go to Step 17.



---

## Chapter 7. Moving the System Unit

This chapter provides important information about moving the system unit.

---

### Moving the System Unit Safely

**Attention:** Damage as a result of improper handling may void your equipment warranty. Contact your local service representative to obtain packing materials or assistance when preparing your system for moving.

A trained service representative should be contacted to move your system. The following precautions should be taken if you decide to move the unit yourself:

**Note:** For a translation of these notices, see *System Unit Safety Information*.

#### **DANGER**

**An electrical outlet that is not correctly wired could place hazardous voltage on metal parts of the system or the devices that attach to the system. It is the responsibility of the customer to ensure that the outlet is correctly wired and grounded to prevent an electrical shock.**

**Before installing or removing signal cables, ensure that the power cables for the system unit and all attached devices are unplugged.**

**When adding or removing any additional devices to or from the system, ensure that the power cables for those devices are unplugged before the signal cables are connected. If possible, disconnect all power cables from the existing system before you add a device.**

**Use one hand, when possible, to connect or disconnect signal cables to prevent a possible shock from touching two surfaces with different electrical potentials.**

**During an electrical storm, do not connect cables for display stations, printers, telephones, or station protectors for communications lines.**

#### **CAUTION:**

**This product is equipped with a three-wire power cable and plug for the user's safety. Use this power cable in conjunction with a properly grounded electrical outlet to avoid electrical shock.**

#### **DANGER**

**To prevent shock hazard, disconnect the power cable from the electrical outlet before relocating the system.**

1. Set the power switches on the attached devices and system unit to Off.
2. Unplug all attached devices and the system unit from power outlets.
3. Be sure to label all of the cables and cords connected to the rear of the system unit as you disconnect them.
4. In the location you are moving to, check all of the power outlets for correct wiring, voltage, and grounding before connecting any of the devices or the system unit.
5. Be sure that all memory, CPU, and adapter cards are properly seated before you turn on the system power.
6. Connect all signal cables before connecting any device or the system unit to the power outlets.

---

## Appendix A: Supplies

This appendix contains a list of supplies and the part numbers needed to order them.

<b>Part Number</b>	<b>Description</b>
6404088	3.5-Inch 1.0M-byte Blank Diskette (box of 10)
6404083	3.5-Inch 2.0M-byte Blank Diskette (box of 10)
72X6111	3.5-Inch 4.0MB Blank Diskette (Box of 10)
21F8763	4 mm Cleaning Cartridge
21F8758	4 mm DDS     Data Tape Cartridge (five-pack)
21F8762	4 mm DDS     Diagnostic Cartridge
8191160	4 mm DDS2 Data Cartridge (five-pack)
8191146	4 mm DDS2 Diagnostic Cartridge
21F8732	1/4-Inch, 1.2 GB Data Tape Cartridge (5-pack)
21F8587	1/4-Inch, 525 MB Data Tape Cartridge (5-pack)
21F8588	1/4-Inch, 150 MB Data Tape Cartridge (5-pack)
21F8570	1/4-Inch, Cartridge Head Cleaning Kit
21F8595	8 mm Data Tape Cartridge (five-pack)
21F8593	8 mm Cleaning Tape Cartridge
21F8577	8 mm Test Tape Cartridge.
0352465	1/2-Inch, Head Cleaning Kit
13F5647	Tape Cleaning Solution
33F8354	Lithium Battery

In the United States, you can order these supplies by calling toll-free **1-800-438-2468**, or you can FAX your inquiry to **1-800-522-3422**.

---

## Ordering Keys

For protection against unauthorized key duplication, the key mode switch is equipped with a Medeco® high-security lock. Keys for this lock are a factory restricted series, and duplicate keys are *not* available through normal commercial channels. The metal code tag supplied with your original keys authorizes you to purchase additional keys direct from the Medeco factory. The additional key supplied and the metal tag should be stored in a secured area.

To obtain information or replacement keys, use the list below to contact the Medeco distributor most convenient to you. Complete a copy of the order form and mail it to the distributor. As a safety precaution, Medeco will not honor orders that do not include both the code tag and the official order form.

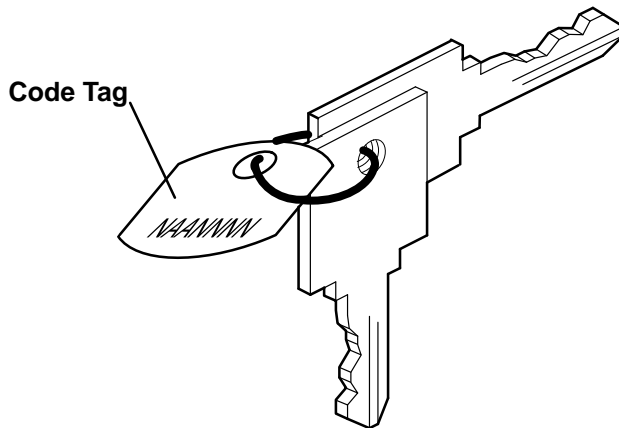

Medeco  
Department KLC  
P.O. Box 3075  
Salem, VA 24153  
United States of America

Claus Clausen  
89a Authur Road  
Wimbledon Park, London  
SW 19 7DP England  
Tel: 011-44-81-946-2823  
Fax: 011-44-81-946-2286

Y.S. Chae  
Geoho Corporation  
2nd Fl. Kyung Bldg.  
244-7 Poi-Dong  
Gangnam-Ku  
Seoul, Korea  
Tel: 011-82-02-579-1280  
FAX: 011-82-02-579-1282

ATM Lock A Safe Co. Pty. Ltd.  
11/44 Ourimbah Road, P. O. Box 300  
Tweed Head, N.S.W. 2485  
Australia  
Tel: 011-61-075-36-7600  
FAX: 011-61-075-36-7605

Ricardo DeCastro  
Calle 22 No 3-30, Ofc. 201  
P. O. Box A.A. No. 39955  
Bogota, Colombia Sur America  
Tel: 011-57-1-268-5827 or 6180  
Fax: 011-57-1-268-2628

Moshe Rotner  
R.M. Rotan Marketing  
34 Nordau Street, Herzlia B  
P.O. Box 5138, Herzlia  
Israel  
Tel: 011-972-9-545640  
FAX: 011-972-9-584275

## Key Reorder Form

A copy of this form, when accompanied by the metal code tag supplied with the original keys, represents an authorized order for additional factory keys.

Please indicate the quantity required and enclose a check or money order for the appropriate amount.

Number of keys required\_\_\_\_\_

### Please Type or Print Your Return Address

Name\_\_\_\_\_

Address\_\_\_\_\_

City\_\_\_\_\_

State\_\_\_\_\_ Zip\_\_\_\_\_

Country\_\_\_\_\_

Select an address from the list provided on the previous page, and mail a copy of this form to that location.

Your key code tag will be returned with your new keys.

**Note:** No orders will be processed without both the code tag and a copy of this form.



---

## Appendix B. Three-Digit Display Numbers

This appendix contains lists of the various numbers and characters that may display in the three-digit display. Determine the type of operation being performed, then use the list for that type operation.

---

### Built-In Self-Test (BIST) Indicators

100	BIST completed successfully; control was passed to IPL ROS.
101	BIST started following reset.
102	BIST started following power-on reset.
103	BIST could not determine the system model number.
104	Equipment conflict; BIST could not find the CBA.
105	BIST could not read from the OCS EPROM
106	BIST failed: CBA not found.
111	OCS stopped; BIST detected a module error.
112	A checkstop occurred during BIST; checkstop results could not be logged out.
113	Three checkstops have occurred.
120	BIST starting a CRC check on the 8752 EPROM.
121	BIST detected a bad CRC in the first 32K-bytes of the OCS EPROM.
122	BIST started a CRC check on the first 32K-bytes of the OCS EPROM.
123	BIST detected a bad CRC on the OCS area of NVRAM.
124	BIST started a CRC check on the OCS area of NVRAM.
125	BIST detected a bad CRC on the time-of-day area of NVRAM.
126	BIST started a CRC check on the time-of-day area of NVRAM.
127	BIST detected a bad CRC on the 8752 EPROM.
130	BIST presence test started.
140	Running BIST. (Box Manufacturing Mode Only)
142	Box manufacturing mode operation.
143	Invalid memory configuration.
144	Manufacturing test failure.
151	BIST started AIPGM test code.
152	BIST started DCLST test code.
153	BIST started ACLST test code.
154	BIST started AST test code.
160	Bad EPOW Signal/Power status signal.
161	BIST being conducted on BUMP I/O.
162	BIST being conducted on JTAG.
163	BIST being conducted on Direct I/O.
164	BIST being conducted on CPU.
165	BIST being conducted on DCB and Memory.
166	BIST being conducted on Interrupts.
170	BIST being conducted on Multi-Processors.
180	Logout in progress.
182	BIST COP bus not responding.
185	A checkstop condition occurred during the BIST.
186	System logic-generated checkstop (Model 250 only).
187	Graphics-generated checkstop (Model 250).
195	BIST logout completed.
888	BIST did not start.

---

## Power-On Self-Test (POST) Indicators

200	IPL attempted with keylock in the Secure position.
201	IPL ROM test failed or checkstop occurred (irrecoverable).
202	Unexpected machine check interrupt.
203	Unexpected data storage interrupt.
204	Unexpected instruction storage interrupt.
205	Unexpected external interrupt.
206	Unexpected alignment interrupt.
207	Unexpected program interrupt.
208	Unexpected floating point unavailable interrupt.
209	Unexpected SVC interrupt.
20c	L2 cache POST error. (The display shows a solid 20c for 5 seconds.)
210	Unexpected SVC interrupt.
211	IPL ROM CRC comparison error (irrecoverable)
212	RAM POST memory configuration error or no memory found (irrecoverable).
213	RAM POST failure (irrecoverable)
214	Power status register failed (irrecoverable).
215	A low-voltage condition is present (irrecoverable).
216	IPL ROM code being uncompressed into memory.
217	End of boot list encountered.
218	RAM POST is looking for good memory.
219	RAM POST bit map is being generated.
21c	L2 cache is not detected. (The display shows a solid 21c for 2 seconds.)
220	IPL control block is being initialized.
221	NVRAM CRC comparison error during AIX IPL(key mode switch in Normal mode). Reset NVRAM by reaccomplishing IPL in Service mode. For systems with an internal, direct-bus-attached (DBA) disk, IPL ROM attempted to perform an IPL from that disk before halting with this three-digit display value.
222	Attempting a Normal mode IPL from Standard I/O planar-attached devices specified in NVRAM IPL Devices List.
223	Attempting a Normal mode IPL from SCSI-attached devices specified in NVRAM IPL Devices List.
224	Attempting a Normal mode IPL from 9333 subsystem device specified in NVRAM IPL Devices List.
225	Attempting a Normal mode IPL from 7012 DBA disk-attached devices specified in NVRAM IPL Devices List.
226	Attempting a Normal mode restart from Ethernet specified in NVRAM IPL Devices List.
227	Attempting a Normal mode restart from Token Ring specified in NVRAM IPL Devices List.
228	Attempting a Normal mode IPL from NVRAM expansion code.
229	Attempting a Normal mode IPL from NVRAM IPL Devices List; cannot IPL from any of the listed devices, or there are no valid entries in the Devices List.
22c	Attempting a normal mode IPL from FDDI specified in NVRAM IPL device list.
230	Attempting a Normal mode restart from adapter feature ROM specified in IPL ROM Device List.
231	Attempting a Normal mode restart from Ethernet specified in IPL ROM Device List.



- 232 Attempting a Normal mode IPL from Standard I/O planar attached devices specified in ROM Default Device List.
- 233 Attempting a Normal mode IPL from SCSI attached devices specified in IPL ROM Default Device List.
- 234 Attempting a Normal mode restart from 9333 subsystem device specified in IPL ROM Device List.
- 235 Attempting a Normal mode IPL from 7012 DBA disk attached devices specified in IPL ROM Default Device List.
- 236 Attempting a Normal mode restart from Ethernet specified in IPL ROM Default Device List.
- 237 Attempting a Normal mode restart from Token Ring specified in IPL ROM Default Device List.
- 238 Attempting a Normal mode restart from Token Ring specified by the operator.
- 239 System failed to restart from the device chosen by the operator.
- 23c Attempting a normal mode IPL from FDDI specified in IPL ROM device list.
- 240 Attempting a Service mode restart from adapter feature ROM.
- 241 Attempting a Normal mode IPL from devices specified in the NVRAM IPL Devices List.
- 242 Attempting a Service mode IPL from Standard I/O planar attached devices specified in NVRAM IPL Devices List.
- 243 Attempting a Service mode IPL from SCSI attached devices specified in NVRAM IPL Devices List.
- 244 Attempting a Service mode restart from 9333 subsystem device specified in NVRAM IPL Devices List.
- 245 Attempting a Service mode IPL from 7012 DBA disk-attached devices specified in NVRAM IPL Devices List.
- 246 Attempting a Service mode restart from Ethernet specified in NVRAM IPL Devices List.
- 247 Attempting a Service mode restart from Token Ring specified in NVRAM Device List.
- 248 Attempting a Service mode IPL from NVRAM expansion code.
- 249 Attempting a Service mode IPL from NVRAM IPL Devices List; cannot IPL from any of the listed devices, or there are no valid entries in the Devices List.
- 24c Attempting a service mode IPL from FDDI specified in NVRAM IPL device list.
- 250 Attempting a Service mode restart from adapter feature ROM specified in IPL ROM Device List.
- 251 Attempting a Service mode restart from Ethernet specified in IPL ROM Default Device List.
- 252 Attempting a Service mode IPL from Standard I/O planar attached devices specified in ROM Default Device List.
- 253 Attempting a Service mode IPL from SCSI-attached devices specified in IPL ROM Default Device List.
- 254 Attempting a Service mode restart from 9333 subsystem device specified in IPL ROM Devices List.
- 255 Attempting a Service mode IPL from 7012 DBA disk-attached devices specified in IPL ROM Default Device List.
- 256 Attempting a Service mode restart from Ethernet specified in IPL ROM Devices List.
- 257 Attempting a Service mode restart from Token Ring specified in IPL ROM Devices List.

258 Attempting a Service mode restart from Token Ring specified by the operator.

259 Attempting a Service mode IPL from FDDI specified by the operator.

25c Attempting a Service mode IPL from FDDI specified in IPL ROM device list.

260 Information is being displayed on the display console.

261 No supported local system display adapter was found.

262 A keyboard was not detected as being connected to the system's keyboard port.

263 Attempting a Normal mode restart from adapter feature ROM specified in NVRAM Device List.

269 Stalled state – the system is unable to IPL.

271 Mouse and Mouse port POST.

272 Tablet Port POST.

277 Auto Token-Ring LANstreamer MC 32 Adapter.

278 Video ROM scan POST.

279 FDDI POST.

280 3com Ethernet POST.

281 Keyboard POST executing.

282 Parallel port POST executing.

283 Serial port POST executing.

284 POWER Gt1 graphics adapter POST executing.

285 POWER Gt3 graphics adapter POST executing.

286 Token-Ring adapter POST executing.

287 Ethernet adapter POST executing.

288 Adapter card slots being queried.

289 POWER GT0 Display Adapter POST.

290 IOCC POST error (irrecoverable)

291 Standard I/O POST running.

292 SCSI POST running.

293 7012 DBA disk POST running.

294 IOCC bad TCW SIMM in slot location J being tested.

295 Graphics Display adapter POST, color or grayscale.

296 ROM scan POST.

297 System model number does not compare between OCS and ROS (irrecoverable).

298 Attempting a software IPL.

299 IPL ROM passed control to the loaded program code.

301 Flash Utility ROM test failed or checkstop occurred (irrecoverable).

302 Flash Utility ROM: User prompt, move the key to the service position in order to perform an optional Flash Update. LED 302 will only appear if the key switch is in the secure position. This signals the user that a Flash Update may be initiated by moving the key switch to the service position. If the key is moved to the service position then LED 303 will be displayed, this signals the user to press the reset button and select optional Flash Update.

303 Flash Utility ROM: User prompt, press the reset button in order to perform an optional Flash Update. LED 302 will only appear if the key switch is in the secure position. This signals the user that a Flash Update may be initiated by moving the key switch to the service position. If the key is moved to the service position LED 303 will be displayed, this signals the user to press the reset button and select optional Flash Update.

304 Flash Utility ROM IOCC POST error (irrecoverable).

305 Flash Utility ROM standard I/O POST running.

306 Flash Utility ROM is attempting IPL from Flash Update media device.

307 Flash Utility ROM system model number does not compare between OCS and ROM (irrecoverable).

308 Flash Utility ROM: IOCC TCW memory is being tested.

309 Flash Utility ROM passed control to a Flash Update Boot Image.

311 Flash Utility ROM CRC comparison error (irrecoverable).

312 Flash Utility ROM RAM POST memory configuration error or no memory found (irrecoverable).

313 Flash Utility ROM RAM POST failure (irrecoverable).

314 Flash Utility ROM Power status register failed (irrecoverable).

315 Flash Utility ROM detected a low voltage condition.

318 Flash Utility ROM RAM POST is looking for good memory.

319 Flash Utility ROM RAM POST bit map is being generated.

322 CRC error on media Flash Image. No Flash Update performed.

323 Current Flash Image is being erased.

324 CRC error on new Flash Image after Update was performed. (Flash Image is corrupted.)

325 Flash Update successful and complete.

## Configuration Program Indicators

5c0 Streams-based hardware drive being configured.

5c1 Streams-based X.25 protocol being configured.

5c2 Streams-based X.25 COMIO emulator driver being configured.

5c3 Streams-based X.25 TCP/IP interface driver being configured.

5c4 FCS adapter device driver being configured.

5c5 SCB network device driver for FCS is being configured.

5c6 AIX SNA channel being configured.

500 Querying Standard I/O slot.

501 Querying card in Slot 1.

502 Querying card in Slot 2.

503 Querying card in Slot 3.

504 Querying card in Slot 4.

505 Querying card in Slot 5.

506 Querying card in Slot 6.

507 Querying card in Slot 7.

508 Querying card in Slot 8.

510 Starting device configuration.

511 Device configuration completed.

512 Restoring device configuration files from media.

513 Restoring basic operating system installation files from media.

516 Contacting server during network boot.

517 Mounting client remote file system during network IPL.

518 Remote mount of the root and /usr file systems failed during network boot.

520 Bus configuration running.

521 **/etc/init** invoked **cfgmgr** with invalid options; **/etc/init** has been corrupted or incorrectly modified (irrecoverable error).

522 The configuration manager has been invoked with conflicting options (irrecoverable error).

523 The configuration manager is unable to access the ODM database (irrecoverable error).

524 The configuration manager is unable to access the config rules object in the ODM database (irrecoverable error).

525 The configuration manager is unable to get data from a customized device object in the ODM database (irrecoverable error).

526 The configuration manager is unable to get data from a customized device driver object in the ODM database (irrecoverable error).

527 The configuration manager was invoked with the phase 1 flag; running phase 1 at this point is not permitted (irrecoverable error).

528 The configuration manager cannot find sequence rule, or no program name was specified in the ODM database (irrecoverable error).

529 The configuration manager is unable to update ODM data (irrecoverable error).

530 The program **savebase** returned an error.

531 The configuration manager is unable to access the PdAt object class (irrecoverable error).

532 There is not enough memory to continue (malloc failure); irrecoverable error.

533 The configuration manager could not find a configure method for a device.

534 The configuration manager is unable to acquire database lock (irrecoverable error).

535 HIPPI diagnostics interface driver being configured.

536 The configuration manager encountered more than one sequence rule specified in the same phase (irrecoverable error).

537 The configuration manager encountered an error when invoking the program in the sequence rule.

538 The configuration manager is going to invoke a configuration method.

539 The configuration method has terminated, and control has returned to the configuration manager.

551 IPL Varyon is running.

552 IPL Varyon failed.

553 IPL phase 1 is complete.

554 Unable to define NFS swap device during network boot.

555 Unable to create NFS swap device during network boot.

556 Logical Volume Manager encountered error during IPL varyon.

557 The root filesystem will not mount.

558 There is not enough memory to continue the IPL.

559 Less than 2 M bytes of good memory are available to load the AIX kernel.

570 Virtual SCSI devices being configured.

571 HIPPI common function device driver being configured.

572 HIPPI IPI-3 master transport driver being configured.

573 HIPPI IPI-3 slave transport driver being configured.

574 HIPPI IPI-3 transport services user interface device driver being configured.

575 A 9570 disk-array driver is being configured.

576 Generic async device driver being configured.

577 Generic SCSI device driver being configured.

578 Generic commo device driver being configured.

579 Device driver being configured for a generic device.

580 HIPPI TCPIP network interface driver being configured.

581 Configuring TCPIP.

582 Configuring Token-Ring data link control.

583 Configuring an Ethernet data link control.

584 Configuring an IEEE ethernet data link control.

585 Configuring an SDLC MPQP data link control.

586 Configuring a QLLC X.25 data link control.

587 Configuring a NETBIOS.

588 Configuring a Bisync Read-Write (BSCRW).

589 SCSI target mode device being configured.

590 Diskless remote paging device being configured.

591 Configuring an LVM device driver.

592 Configuring an HFT device driver.

593 Configuring SNA device drivers.  
 594 Asynchronous I/O being defined or configured.  
 595 X.31 pseudo device being configured.  
 596 SNA DLC/LAPE pseudo device being configured.  
 597 OCS software being configured.  
 598 OCS hosts being configured during system reboot.  
 599 Configuring FDDI data link control.  
 600 Starting network boot portion of **/sbin/rc.boot**  
 602 Configuring network parent devices.  
 603 **/usr/lib/methods/defsys, /usr/lib/methods/cfgsys, or**  
**/usr/lib/methods/cfgbus** failed.  
 604 Configuring physical network boot device.  
 605 Configuration of physical network boot device failed.  
 606 Running **/usr/sbin/ifconfig** on logical network boot device.  
 607 **/usr/sbin/ifconfig** failed.  
 608 Attempting to retrieve the **client.info** file with **tftp**. Note that a flashing 608  
 indicates multiple attempt(s) to retrieve the **client\_info** file are occurring.  
 609 The **client.info** file does not exist or it is zero length.  
 610 Attempting remote mount of NFS file system.  
 611 Remote mount of NFS file system failed.  
 612 Accessing remote files; unconfiguring network boot service.  
 614 Configuring local paging devices.  
 615 Configuration of local paging devices fails.  
 616 Converting from diskless to dataless configuration.  
 617 Diskless to dataless configuration failed.  
 618 Configuring remote (NFS) paging devices.  
 619 Configuration of remote (NFS) paging devices failed.  
 620 Updating special device files and ODM in permanent filesystem with data  
 from boot RAM filesystem.  
 622 Boot process configuring for operating system installation.  
 77c Progress indicator. A 1.0 GB 16-bit SCSI disk drive being identified or  
 configured.  
 700 Progress indicator. A 1.1 GB 8-bit SCSI disk drive being identified or  
 configured.  
 701 Progress indicator. A 1.1 GB 16-bit SCSI disk drive being identified or  
 configured.  
 702 Progress indicator. A 1.1 GB 16-bit differential SCSI disk drive being  
 identified or configured.  
 703 Progress indicator. A 2.2 GB 8-bit SCSI disk drive being identified or  
 configured.  
 704 Progress indicator. A 2.2 GB 16-bit SCSI disk drive being identified or  
 configured.  
 705 The configuration method for the 2.2 GB 16-bit differential SCSI disk drive is  
 being run. If an irrecoverable error occurs, the system halts.  
 706 Progress indicator. A 4.5 GB 16-bit SCSI disk drive being identified or  
 configured.  
 707 Progress indicator. A 4.5 GB 16-bit differential SCSI disk drive being  
 identified or configured.  
 708 Progress indicator. A L2 cache is being identified or configured.  
 710 POWER GXT150M graphics adapter being identified or configured.  
 711 Unknown adapter being identified or configured.  
 712 Graphics slot bus configuration is executing.  
 713 The IBM ARTIC960 device is being configured.  
 714 A video capture adapter is being configured.

715 The Ultimedia Services audio adapter is being configured. This LED displays briefly on the panel.

717 TP Ethernet Adapter being configured.

718 GXT500 Graphics Adapter being configured.

720 Unknown read/write optical drive type being configured.

721 Unknown disk or SCSI device being identified or configured.

722 Unknown disk being identified or configured.

723 Unknown CDROM being identified or configured.

724 Unknown tape drive being identified or configured.

725 Unknown display device being identified or configured.

726 Unknown input device being identified or configured.

727 Unknown async device being identified or configured.

728 Parallel printer being identified or configured.

729 Unknown parallel device being identified or configured.

730 Unknown diskette drive being identified or configured.

731 pty being identified or configured.

732 Unknown SCSI initiator type being configured.

733 7GB 8mm tape drive being configured.

734 4x SCSI-2 CD-ROM Drive.

741 1080MB SCSI Disk Drive

745 16GB 4mm Tape Auto Loader

748 MCA keyboard/mouse adapter being configured.

754 1.1GB 16-bit SCSI disk drive being configured.

755 2.2GB 16-bit SCSI disk drive being configured.

756 4.5GB 16-bit SCSI disk drive being configured.

757 External 13GB 1.5M/s 1/4 inch tape being configured.

772 4.5GB SCSI F/W Disk Drive.

773 9.1GB SCSI F/W Disk Drive.

77c Progress indicator. A 1.0 GB 16-bit SCSI disk drive being identified or configured.

783 4mm DDS-2 Tape Autoloader.

789 2.6GB External Optical Drive.

794 10/100MB Ethernet PX MC Adapter

797 Turboways 155 UTP/STP ATM Adapter being identified or configured.

798 Video streamer adapter being identified or configured.

800 Turboways 155 MMF Adapter being identified or configured.

80c SSA 4-Port Adapter being identified or configured.

811 Processor complex being identified or configured.

812 Memory being identified or configured.

813 Battery for time-of-day, NVRAM, and so on being identified or configured, or system I/O Control Logic being identified or configured.

814 NVRAM being identified or configured.

815 Floating-point processor test

816 Operator panel logic being identified or configured.

817 Time-of-day logic being identified or configured.

819 Graphics input device adapter being identified or configured.

821 Standard keyboard adapter being identified or configured.

823 Standard mouse adapter being identified or configured.

824 Standard tablet adapter being identified or configured.

825 Standard speaker adapter being identified or configured.

826 Serial Port 1 adapter being identified or configured.

827 Parallel port adapter being identified or configured.

828 Standard diskette adapter being identified or configured.

831 3151 adapter being identified or configured, or Serial Port 2 being identified or configured.

834 64-port async controller being identified or configured.

835 16-port async concentrator being identified or configured.

836 128-port async controller being identified or configured.

837 128-port remote async controller being identified or configured.

838 Network Terminal Accelerator Adapter being identified or configured.

839 7318 Serial Communications Server being configured.

841 8-port async adapter (EIA-232) being identified or configured.

842 8-port async adapter (EIA-422A) being identified or configured.

843 8-port async adapter (MIL-STD 188) being identified or configured.

844 7135 RADiant Array disk drive subsystem controller being identified or configured.

845 7135 RADiant Array disk drive subsystem drawer being identified or configured.

846 RADiant Array SCSI 1.3GB Disk Drive.

847 16-port serial adapter (EIA-232) being identified or configured.

848 16-port serial adapter (EIA-422) being identified or configured.

849 X.25 communications adapter being identified or configured.

850 Token-Ring network adapter being identified or configured.

852 Ethernet adapter being identified or configured.

854 3270 Host Connection Program/6000 connection being identified or configured.

855 4-port multiprotocol adapter being identified or configured.

857 FSLA adapter being identified or configured.

858 5085/5086/5088 adapter being identified or configured.

859 FDDI adapter being identified or configured.

85c Progress indicator. Token-Ring High-Performance LAN adapter is being identified or configured.

861 Optical adapter being identified or configured.

862 Block multiplexer channel adapter being identified or configured.

865 370 serial channel adapter being identified or configured.

866 SCSI adapter being identified or configured.

867 Async expansion adapter being identified or configured.

868 SCSI adapter being identified or configured.

869 SCSI adapter being identified or configured.

870 Serial disk drive adapter being identified or configured.

871 Graphics subsystem adapter being identified or configured.

872 Grayscale graphics adapter being identified or configured.

874 Color graphics adapter being identified or configured.

875 Vendor generic communications adapter being configured.

876 8-bit color graphics processor being identified or configured.

877 POWER Gt3/POWER Gt4 being identified or configured.

878 POWER Gt4 graphics processor card being configured.

879 24-bit color graphics card, MEV2.

880 POWER Gt1 being identified or configured.

887 Integrated Ethernet adapter being identified or configured.

889 SCSI adapter being identified or configured.

890 SCSI-2 Fast/Wide Adapter/A being identified or configured.

891 Vendor SCSI adapter being identified or configured.

892 Vendor display adapter being identified or configured.

893 Vendor LAN adapter being identified or configured.

894 Vendor async communications adapter being identified or configured.

895 Vendor IEEE 488 adapter being identified or configured.

896 Vendor VME bus adapter being identified or configured.  
 897 S/370 channel emulator adapter being identified or configured.  
 898 POWER Gt1x graphics adapter being identified or configured.  
 899 3490 attached tape drive being identified or configured.  
 89c Progress indicator. A multimedia SCSI CD-ROM is being identified or configured.  
 901 Vendor SCSI device being identified or configured.  
 902 Vendor display device being identified or configured.  
 903 Vendor async device being identified or configured.  
 904 Vendor parallel device being identified or configured.  
 905 Vendor other device being identified or configured.  
 908 POWER GXT1000 Graphics subsystem being identified or configured.  
 910 1/4GB Fibre Channel/266 Standard Adapter being identified or configured.  
 911 Fibre Channel/1063 Standard Adapter Short Wave.  
 912 2.0G-byte SCSI-2 differential disk drive being identified or configured.  
 913 1.0G-byte differential disk drive being identified or configured.  
 914 5G-byte 8 mm differential tape drive being identified or configured.  
 915 4 G-byte 4 mm tape drive being identified or configured.  
 916 Non-SCSI vendor tape adapter being identified or configured.  
 917 Progress indicator. 2.0 GB 16-bit differential SCSI disk drive being identified or configured.  
 918 Progress indicator. 2GB 16-bit single-ended SCSI disk drive being identified or configured.  
 920 Bridge box being identified or configured.  
 921 101 keyboard being identified or configured.  
 922 102 keyboard being identified or configured.  
 923 Kanji keyboard being identified or configured.  
 924 Two-button mouse being identified or configured.  
 925 Three-button mouse being identified or configured.  
 926 Tablet Model 21 being identified or configured.  
 927 Tablet Model 22 being identified or configured.  
 928 Standard speaker being identified or configured.  
 929 Dials being identified or configured.  
 930 Lighted Program Function Keys (LPFK) being identified or configured.  
 931 IP router being identified or configured.  
 933 Async planar being identified or configured.  
 934 Async expansion drawer being identified or configured.  
 935 3.5-inch diskette drive being identified or configured.  
 936 5.25-inch diskette drive being identified or configured.  
 937 An HIPPI adapter is being configured.  
 942 POWER GXT 100 graphics adapter being identified or configured.  
 943 Progress indicator. 3480 and 3490 control units attached to a System/370 Channel Emulator/A adapter are being identified or configured.  
 944 100MB ATM adapter being identified or configured.  
 945 1.0G-byte SCSI differential disk drive being identified or configured.  
 946 Serial port 3 adapter is being identified or configured.  
 947 Progress indicator. A 730MB SCSI disk drive is being configured.  
 948 Portable disk drive being identified or configured.  
 949 Unknown direct bus-attach device being identified or configured.  
 950 Missing SCSI device being identified or configured.  
 951 670M-byte SCSI disk drive being identified or configured.  
 952 355M-byte SCSI disk drive being identified or configured.  
 953 320M-byte SCSI disk drive being identified or configured.  
 954 400M-byte SCSI disk drive being identified or configured.



955	857M-byte SCSI disk drive being identified or configured.
956	670M-byte SCSI disk drive electronics card being identified or configured.
957	120M-byte DBA disk drive being identified or configured.
958	160M-byte DBA disk drive being identified or configured.
959	160M-byte SCSI disk drive being identified or configured.
960	1.37G-byte SCSI disk drive being identified or configured.
964	Internal 20GB 8mm tape drive identified or configured.
968	1.0G-byte SCSI disk drive being identified or configured.
970	Half-inch, 9-track tape drive being identified or configured.
971	150M-byte quarter-inch tape drive being identified or configured.
972	2.3G-byte 8-mm SCSI tape drive being identified or configured.
973	Other SCSI tape drive being identified or configured.
974	CD-ROM drive being identified or configured.
975	Progress indicator. An optical disk drive is being identified or configured.
977	M-Audio capture and playback adapter being identified or configured.
981	540M-byte SCSI-2 single-ended disk drive being identified or configured.
984	1GB 8-bit disk drive being identified or configured.
985	M-Video capture and playback adapter being identified or configured.
986	2.4G-byte SCSI disk drive being identified or configured.
987	Progress indicator. Enhanced SCSI CD-ROM drive is being identified or configured.
989	200M-byte SCSI disk drive being identified or configured.
990	2.0G-byte SCSI-2 single-ended disk drive being identified or configured.
991	525M-byte 1/4-inch cartridge tape drive being identified or configured.
994	5G-byte 8 mm tape drive being identified or configured.
995	1.2G-byte 1/4-inch tape drive being identified or configured.
996	1.0G-byte SCSI disk drive being identified or configured.
997	FDDI adapter being identified or configured.
998	2.0G-byte 4 mm tape drive being identified or configured.
999	Data compression adapter being identified or configured.
D81	T2 Ethernet Adapter being configured.

---

## Dump Progress Indicators

**Note:** When a lowercase *c* is listed, it displays in the lower half of the seven-segment character position. The leftmost position is blank on the following codes.

0c0	The dump completed successfully.
0c1	The dump failed due to an I/O error.
0c2	A user-requested dump has started.
0c3	The dump is inhibited.
0c4	The dump did not complete. A partial dump may be present.
0c5	Dump failed to start; the dump program could not write to the dump device.
0c6	A dump to the secondary dump device was requested. Make the secondary dump device ready; then press the Ctrl-Alt-Numpad2 key sequence.
0c7	Reserved.
0c8	The dump function is disabled; no primary device is configured.
0c9	A dump is in progress.
0cc	Unknown dump failure.

---

## Diagnostic Load Progress Indicators

**Note:** When a lowercase *c* is listed, it displays in the lower half of the seven-segment character position.

c01	Insert the first diagnostic diskette.
c02	Diskettes inserted out of sequence
c03	The wrong diskette is in diskette drive.
c04	The loading stopped with an a non-recoverable error.
c05	A diskette error occurred.
c06	The <b>rc.boot</b> configuration shell script is unable to determine type of boot.
c07	Insert the next diagnostic diskette.
c08	RAM file system started incorrectly.
c09	The diskette drive is reading or writing a diskette.
c20	An unexpected halt occurred, and the system is configured to enter the kernel debug program instead of entering a system dump.
c21	The <b>lfconfig</b> command was unable to configure the network for the client network host.
c22	The <b>ttp</b> command was unable to read client's <i>ClientHostName.Info</i> file during a client network boot.
c24	Unable to read client's <i>ClientHostName.Info</i> file during a client network boot.
c25	Client did not mount remote miniroot during network install.
c26	Client did not mount the <b>/usr</b> file system during the network boot.
c29	The system was unable to configure the network device.
c31	Select the console display for the diagnostics. To select "No console display," set the key mode switch to Normal then to Service. The diagnostic programs will then load and run the diagnostics automatically.
c32	A direct-attached display (HFT) was selected.
c33	A tty terminal attached to serial ports S1 or S2 was selected.
c34	A file was selected. The console messages store in a file.
c40	Configuration files are being restored.
c41	Could not determine the boot type or device.
c42	Extracting data files from diskette.
c43	Cannot access the boot/install tape.
c44	Initializing installation database with target disk information.
c45	Cannot configure the console.
c46	Normal installation processing.
c47	Could not create a physical volume identifier (PVID) on disk.
c48	Prompting you for input.
c49	Could not create or form the JFS log.
c50	Creating root volume group on target disks.
c51	No paging devices were found.
c52	Changing from RAM environment to disk environment.
c53	Not enough space in the <b>/tmp</b> directory to do a preservation installation.
c54	Installing either BOS or additional packages.
c55	Could not remove the specified logical volume in a preservation installation.
c56	Running user-defined customization.
c57	Failure to restore BOS.
c58	Displaying message to turn the key.
c59	Could not copy either device special files, device ODM, or volume group information from RAM to disk.
c61	Failed to create the boot image.
c70	Problem Mounting diagnostic CDROM disc.

c99                   Diagnostics have completed. This code is only used when there is no console.

---

## Debugger Progress Indicators

c20                   The kernel debugger has started due to an unexpected system halt.

---

## Flashing 888 Message Descriptions

The following information describes both crash and diagnostic messages. See “Reading Flashing 888 Numbers” in Chapter 3 for information about reading the message out.

### Type 102 Message

A crash message (Type 102) contains information about a dump and can occur at any time.

### Crash Codes

000	Unexpected system interrupt.
200	Machine check because of a memory bus error (RAS/CAS parity).
201	Machine check because of a memory timeout.
202	Machine check because of a memory card failure.
203	Machine check because of an out of range address.
204	Machine check because of an attempt to write to ROS.
205	Machine check because of an uncorrectable address parity.
206	Machine check because of an uncorrectable ECC error.
207	Machine check because of an unidentified error.
208	Machine check due to an L2 uncorrectable ECC.
300	Data storage interrupt from the processor.
32x	Data storage interrupt because of an I/O exception from IOCC; x represents the BUID.
38x	Data storage interrupt because of an I/O exception from SLA; x represents the BUID.
400	Instruction storage interrupt.
500	External interrupt because of a scrub memory bus error (RAS/CAS parity).
501	External interrupt because of an unidentified error.
51x	External interrupt because of a DMA memory bus error (RAS/CAS parity); x represents the IOCC number.
52x	External interrupt because of an IOCC channel check; x represents the IOCC number.
53x	External interrupt because of an IOCC bus timeout; x represents the IOCC number.
54x	External interrupt because of an IOCC keyboard check; x represents the IOCC number.
558	There is not enough memory to continue the IPL.
700	Program interrupt.
800	Floating point is not available.

### Dump Status Codes

This field contains the dump progress indicator value. See “Dump Progress Indicators” in this Appendix.

## **Type 103 and 105 Messages**

Message types 103 and 105 contain service information. The information should be recorded on the Problem Summary Form or on a blank sheet of paper.

This message contains the SRN and the location codes for up to four FRUs. The SRN is reported to the service organization and the location codes are needed by the service representative. See "Reading Flashing 888 Numbers" in Chapter 3 for information about the diagnostic information contained within this message.

---

# Index

## Numbers

- 1/4-inch tape drive
  - cleaning the tape path, 2-45
  - tape cartridge
    - compatibility, 2-45
    - environmental considerations, 2-45
    - loading, 2-42
    - retensioning, 2-44
    - setting the write-protect tab, 2-44
    - unloading, 2-43
  - using, 2-41
- 102 message, 3-15
- 103 message, 3-16
- 105 message, 3-18
- 2.3GB 8-mm tape drive
  - cleaning the tape path, 2-25
  - tape cartridge
    - data erasure, 2-23
    - loading, 2-25
    - setting the write-protect tab, 2-22
    - unloading, 2-25
- 3.5-inch diskette
  - loading and unloading, 2-16
  - setting the write protect tab, 2-15
  - types, 2-14
  - using, 2-13
- 3-button mouse, 2-10
- 3-digit display, 3-14
  - BIST indicators, B-1
  - configuration program indicators, B-5
  - debugger progress indicators, B-13
  - diagnostic load progress indicators, B-12
  - dump progress indicators, B-11
  - flashing 888 message descriptions, B-13
  - POST indicators, B-2
  - type 102 message, B-13
  - type 103 message, B-14
  - type 105 message, B-14
- 4.0GB 4-mm tape drive
  - cleaning the tape path, 2-40
  - tape cartridge
    - loading, 2-38
    - setting the write-protect tab, 2-34
    - types, 2-33
    - unloading, 2-39
  - using, 2-36
- 4-mm tape drive
  - cleaning the tape path, 2-40
  - tape cartridge
    - loading, 2-38
    - setting the write-protect tab, 2-34
    - types, 2-33
    - unloading, 2-39
  - using, 2-36
- 5.0GB 8-mm tape drive
  - cleaning the tape path, 2-31
  - tape cartridge
    - data erasure, 2-23
    - loading, 2-29
    - unloading, 2-30
- 8-mm tape drive
  - tape cartridge
    - data erasure, 2-23
    - setting the write-protect tab, 2-22
    - types, 2-21
  - using
    - 2.3GB tape drive, 2-24
    - 5.0GB tape drive, 2-27

## A

- attached systems, 2-5
- attributes
  - communications, 3-8
  - diagnostic programs, default settings, 3-7
  - keyboard, 3-9
  - printer, 3-9

## B

- battery, part number, A-1
- BIST indicators, B-1

## C

- cable guide, 1-3
- CD-ROM disc caddy
  - loading, 2-18, 2-19
  - unloading, 2-19
- CD-ROM drive
  - cleaning, 2-20

- emergency eject, 2-20
  - unloading, 2-19
- certify disk service aid, 4-3
- change configuration service aid, 4-3
- cleaning solution, tape, A-1
- cleaning, tape path
  - 1/4-inch tape drive, 2-45
  - 2.3GB 8-mm tape drive, 2-25
  - 4.0GB 4-mm tape drive, 2-40
  - 4-mm tape drive, 2-40
  - 5.0GB 8-mm tape drive, 2-31
- configuration program indicators, B-5
- control keys, 2-9
- cover removal, 1-9
- covers, 1-2
- create diagnostic diskette package service aid, 4-9

## D

- debugger progress indicators, B-13
- diagnostic programs
  - attached systems, 2-5
  - attributes
    - communication, 3-8
    - default settings, 3-7
    - keyboard, 3-9
    - printer, 3-9
  - modes for running
    - concurrent mode, 3-11
    - maintenance mode, 3-10
    - standalone mode, 3-12
  - operating considerations
    - attached to a 5080 system, 3-6
    - attached to a host system, 3-1
    - identifying a terminal, 3-2
    - running from a TTY terminal, 3-6
    - running from CD-ROM, 3-5
    - running from disk or a server, 3-5
    - running from diskettes, 3-2, 3-4
    - selecting a console, 3-1
  - service aids, 4-1
  - sources for, 3-1
  - system exerciser, 3-13
- diagnostics, load progress indicators, B-12
- dials and LPFK configuration service aid, 4-9
- disc caddy
  - loading, 2-18
  - unloading, 2-19
- disk drive, 1-4

- disk media service aid, 4-3
- disk-based diagnostic update service aid, 4-9
- diskette
  - handling, 2-13
  - loading, 2-16
  - part number, A-1
  - types, 2-14
  - write-protecting, 2-15
- diskette drive
  - description, 1-3
  - using 3.5-inch, 2-13
- diskette media service aid, 4-4
- display configuration service aid, 4-2
- display or alter bootlist service aid, 4-9
- display or alter VPD service aid, 4-2
- display or change configuration or VPD service aid, 4-2
- display or change diagnostic test list service aid, 4-3
- display previous diagnostic results service aid, 4-2
- display test patterns for the multimedia video capture adapter service aid, 4-10
- display test patterns service aid, 4-4
- display VPD service aid, 4-2
- dump progress indicators, B-11

## E

- emergency eject, CD-ROM drive, 2-20
- error report, hardware, 4-10
- external device connector, 1-3, 1-10

## F

- field action, MES, 4-5
- flashing 888 message descriptions, B-13
- format disk service aid, 4-3
- function keys, 2-9

## H

- hand slot, 1-3
- handling
  - diskette, 2-13
  - mouse, 2-11

hardware error report service aid, 4-10  
hardware problem determination procedure, 6-1

## I

indicators  
  BIST progress, B-1  
  configuration program, B-5  
  debugger progress, B-13  
  diagnostic load progress, B-12  
  dump progress, B-11  
  POST progress, B-2  
initial program load (IPL), 2-2  
installation, initial installation, 4-6  
IPL, service, 2-3

## K

key, reorder form, A-3  
key mode switch  
  position, 2-2  
  setting, 2-2  
keyboard, 2-9  
keys, ordering, A-2

## L

loading  
  1/4-inch tape cartridge, 2-42  
  2.3GB 8-mm tape cartridge, 2-25  
  3.5-inch diskette, 2-16  
  4.0GB 4-mm tape drive, 2-38  
  4-mm tape drive, 2-38  
  5.0GB 8-mm tape cartridge, 2-29  
  CD-ROM disc caddy, 2-18, 2-19  
local area network service aid, 4-4  
location code table, 1-7  
location codes, 1-5  
LPFK and dials configuration service aid, 4-9

## M

media positions, 1-3  
MES, field action, 4-5  
messages  
  type 102, B-13  
  type 103, B-14

  type 105, B-14  
microcode download service aid, 4-4  
mode switch  
  description, 1-3  
  setting, 2-2  
mouse  
  care, 2-11  
  cleaning, 2-12  
  handling, 2-11  
moving the system unit, 7-1  
multiple systems, 2-5

## N

number message  
  other numbers, 3-19  
  type 102 message, 3-15  
  type 103 message, 3-16  
  type 105 message, 3-18  
  type 888, 3-14  
  type of message, 3-14  
numeric keypad, 2-9

## O

ordering keys, A-2

## P

part information, power cable and plug, xi  
POST indicators, B-2  
power control capabilities, 2-6  
power switch, 1-3  
power-on light, 2-2, 2-3, 2-6  
power-on self-test (POST), 2-2  
problem determination procedure, 6-1  
product topology service aid, 4-5

## R

reset button  
  description, 1-3  
  using, 2-8  
retensioning, 1/4-inch tape cartridge, 2-44  
rollers, 1-3

## S

- SCSI adapters, 1-1
- SCSI bus service aid, 4-4
- serial number, 1-3
- service aids
  - certify disk, 4-3
  - change configuration, 4-3
  - create diagnostic diskette package, 4-9
  - description, 4-1
  - dials and LPMK configuration, 4-9
  - disk media, 4-3
  - disk-based diagnostic update, 4-9
  - diskette media, 4-4
  - display configuration, 4-2
  - display or alter bootlist, 4-9
  - display or alter VPD, 4-2
  - display or change configuration or VPD, 4-2
  - display or change diagnostic test list, 4-3
  - display previous diagnostic results, 4-2
  - display test patterns, 4-4
  - display test patterns for the multimedia video capture adapter service aid, 4-10
  - display VPD, 4-2
  - format disk, 4-3
  - hardware error report, 4-10
  - local area network, 4-4
  - microcode download, 4-4
  - product topology, 4-5
  - SCSI bus, 4-4
  - service hints, 4-1
  - trace, 4-9
- service hints service aid, 4-1
- service IPL, 2-3
- setting the write-protect tab
  - 1/4-inch tape cartridge, 2-44
  - 3.5-inch diskette, 2-15
  - 4-mm tape cartridge, 2-34
  - 8-mm tape cartridge, 2-22
- shutdown command, 2-6
- shutdown procedure, 2-4
- small computer system interface (SCSI), 1-1
- status lights
  - 1/4-inch tape drive, 2-41
  - 2.3GB 8-mm tape drive, 2-24
  - 4.0GB 4-mm tape drive, 2-36
  - 5.0GB 8-mm tape drive, 2-27
- supplies, A-1
- system unit
  - additional memory card, 1-1

- description, 1-1
- features, 1-2
- moving, 7-1
- slots, 1-1
- starting, 2-4
- typical workstation arrangement, 1-1
- using, 2-1

- system verification procedure, 5-1
  - considerations, 5-1
  - diagnostics
    - loading, 5-2
    - stopping, 5-3
  - running, 5-2

## T

- tape, part number, A-1
- tape cartridge
  - 1/4-inch
    - cleaning, 2-45
    - compatibility, 2-45
    - data capacity, 2-41
    - data efficiency, 2-43
    - environmental considerations, 2-45
    - loading tape drive, 2-42
    - retensioning, 2-44
    - setting the write-protect tab, 2-44
    - unloading tape drive, 2-43
  - 4-mm
    - compatibility, 2-34
    - data capacity, 2-35
    - environment considerations, 2-34
    - erasure, 2-35
    - loading 4.0GB tape drive, 2-38
    - setting the write-protect tab, 2-34
    - types, 2-33
    - unloading 4.0GB tape drive, 2-39
  - 8-mm
    - compatibility, 2-21
    - data efficiency, 2-23
    - environment considerations, 2-22
    - erasure, 2-23
    - loading 2.3GB tape drive, 2-25
    - loading 5.0GB tape drive, 2-29
    - setting the write-protect tab, 2-22
    - types, 2-21
    - unloading 2.3GB tape drive, 2-25
    - unloading 5.0GB tape drive, 2-30
- tape drive
  - 1/4-inch, general information, 2-41
  - 4-mm
    - 4.0GB, 2-36



- general information, 2-32
- 8-mm
  - 2.3GB, 2-24
  - 5.0GB, 2-27
- general information, 2-21
- three-button mouse, 2-10
- three-digit display, 2-2, 2-3, 2-6, B-1
  - BIST indicators, B-1
  - configuration program indicators, B-5
  - debugger progress indicators, B-13
  - diagnostic load progress indicators, B-12
  - dump progress indicators, B-11
  - flashing 888 message descriptions, B-13
  - POST indicators, B-2
  - reading, 2-7
  - type 102 message, B-13
  - type 103 message, B-14
  - type 105 message, B-14
- topology, introduction, 4-5
- trace service aid, 4-9
- type 102 message, B-13
- type 103 message, B-14
- type 105 message, B-14
- typewriter keys, 2-9

## U

- unloading
  - 1/4-inch tape cartridge, 2-43
  - 2.3GB 8-mm tape cartridge, 2-25

- 3.5-inch diskette, 2-16
- 4.0GB 4-mm tape drive, 2-39
- 4-mm tape drive, 2-39
- 5.0GB 8-mm tape cartridge, 2-30
- CD-ROM disc caddy, 2-19
- CD-ROM drive, 2-19

## using

- 1/4-inch tape drive, 2-41
- 2.3GB 8-mm tape cartridge, 2-24
- 3.5-inch diskette drive, 2-13
- 3-button mouse, 2-10
- 4.0GB 4-mm tape drive, 2-36
- 4-mm tape drive, 2-36
- 5.0GB 8-mm tape cartridge, 2-24
- CD-ROM drive, 2-17
- keyboard, 2-9
- reset button, 2-8
- three-button mouse, 2-10

## V

- verification procedure, 5-1

## W

- workstation arrangement, 1-1
- write-protect
  - 1/4-inch tape cartridge, 2-44
  - 4-mm tape cartridge, 2-34
  - 8-mm tape cartridge, 2-22
  - diskette, 2-15



Printed in the United States of America

SA38-0530-00



93H2222

