

HM628128A Series

131,072-word \times 8-bit High Speed CMOS Static RAM

HITACHI

Rev. X
January 1995

The Hitachi HM628128A is a CMOS static RAM organized 128 kword \times 8 bit. It realizes higher density, higher performance and low power consumption by employing 0.8 μ m Hi-CMOS process technology.

It offers low power standby power dissipation; therefore, it is suitable for battery back-up systems. The device, packaged in a 525-mil SOP (460-mil body SOP) or a 600-mil plastic DIP, or a 8 \times 20 mm TSOP with thickness of 1.2 mm, is available for high density mounting. TSOP package is suitable for cards, and reverse type TSOP is also provided.

Features

- High speed
 - Fast access time: 55/70/85/100 ns (max)
- Low power
 - Active: 75 mW (typ)
 - Standby: 10 μ W (typ)
- Single 5 V supply
- Completely static memory
 - No clock or timing strobe required
- Equal access and cycle times
- Common data input and output
 - Three state output
- Directly TTL compatible
 - All inputs and outputs
- Capability of battery back up operation
 - 2 chip selection for battery back up

HM628128A Series

Ordering Information

Type No.	Access time	Package	Type No.	Access time	Package
HM628128ALP-5	55 ns	600-mil 32-pin plastic DIP (DP-32)	HM628128ALT-5	55 ns	8 mm × 20 mm 32-pin TSOP (normal type) (TFP-32D)
HM628128ALP-7	70 ns				
HM628128ALP-8	85 ns				
HM628128ALP-10	100 ns				
HM628128ALP-5L	55 ns		HM628128ALT-5L	55 ns	
HM628128ALP-7L	70 ns		HM628128ALT-7L	70 ns	
HM628128ALP-8L	85 ns		HM628128ALT-8L	85 ns	
HM628128ALP-10L	100 ns		HM628128ALT-10L	100 ns	
HM628128ALP-5SL	55 ns		HM628128ALT-5SL	55 ns	
HM628128ALP-7SL	70 ns		HM628128ALT-7SL	70 ns	
HM628128ALP-8SL	85 ns		HM628128ALT-8SL	85 ns	
HM628128ALP-10SL	100 ns		HM628128ALT-10SL	100 ns	
HM628128ALFP-5	55 ns	525-mil 32-pin plastic SOP (FP-32D)	HM628128ALR-5	55 ns	8 mm × 20 mm 32-pin TSOP (reverse type) (TFP-32DR)
HM628128ALFP-7	70 ns				
HM628128ALFP-8	85 ns				
HM628128ALFP-10	100 ns				
HM628128ALFP-5L	55 ns		HM628128ALR-5L	55 ns	
HM628128ALFP-7L	70 ns		HM628128ALR-7L	70 ns	
HM628128ALFP-8L	85 ns		HM628128ALR-8L	85 ns	
HM628128ALFP-10L	100 ns		HM628128ALR-10L	100 ns	
HM628128ALFP-5SL	55 ns		HM628128ALR-5SL	55 ns	
HM628128ALFP-7SL	70 ns		HM628128ALR-7SL	70 ns	
HM628128ALFP-8SL	85 ns		HM628128ALR-8SL	85 ns	
HM628128ALFP-10SL	100 ns		HM628128ALR-10SL	100 ns	

Pin Arrangement

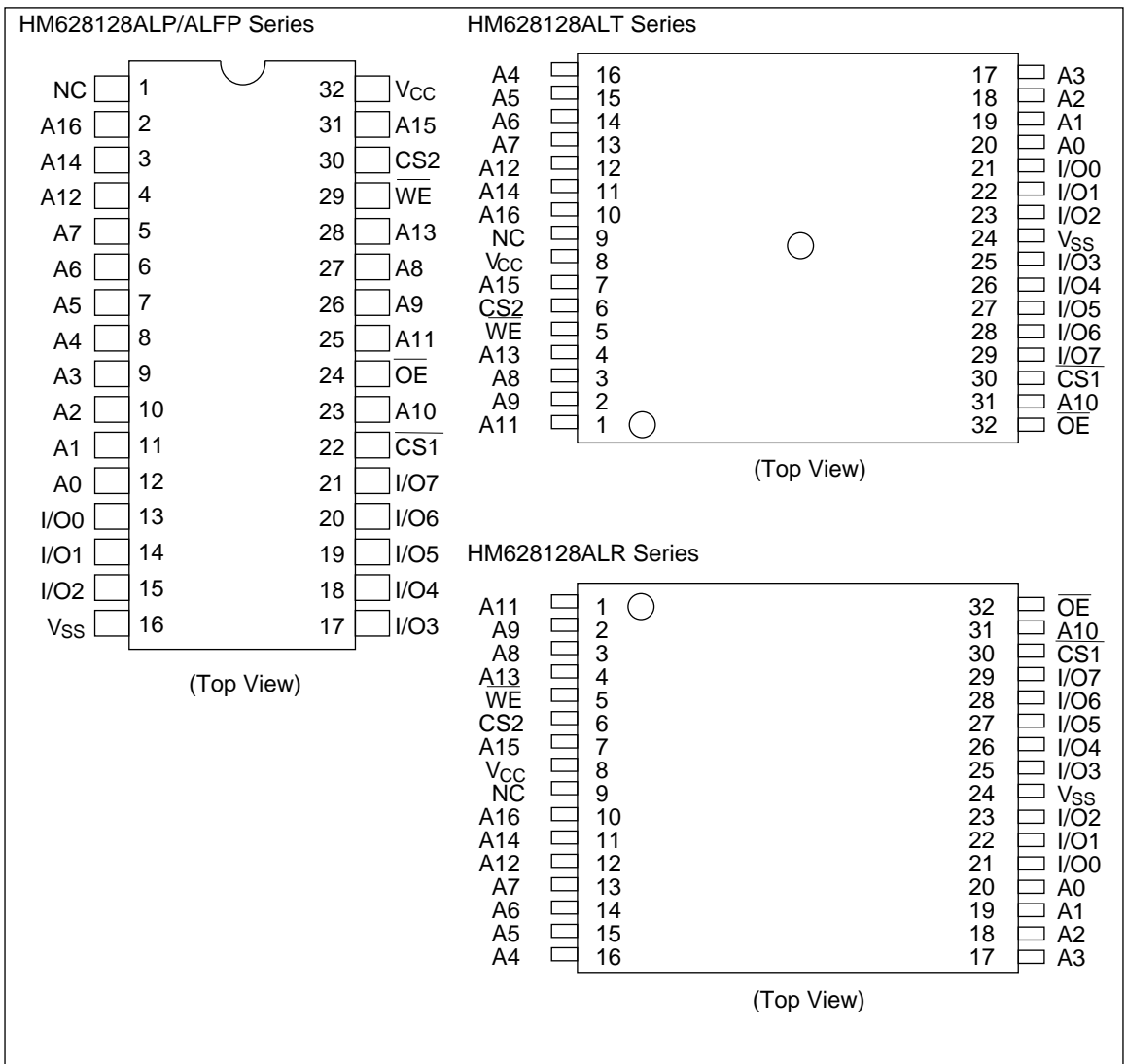

Pin Description

Pin name	Function
A0 – A16	Address
I/O0 – I/O7	Input/output
CS1	Chip select 1
CS2	Chip select 2
WE	Write enable

Pin name	Function
OE	Output enable
NC	No connection
V _{CC}	Power supply
V _{SS}	Ground

HM628128A Series

Block Diagram

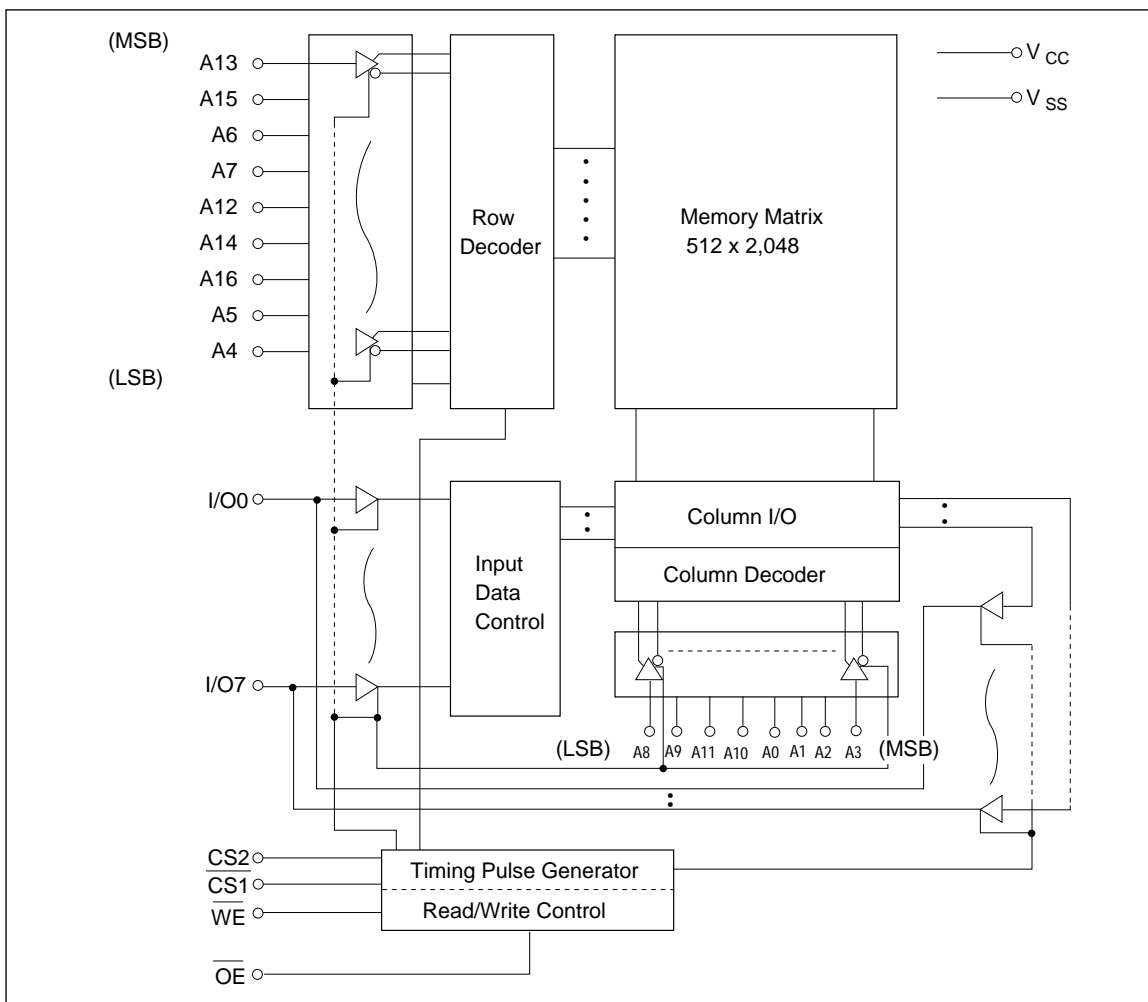

Function Table

$\overline{CS1}$	$\overline{CS2}$	\overline{OE}	\overline{WE}	Mode	V_{CC} current	I/O pin	Ref. cycle
H	X	X	X	Standby	I_{SB}, I_{SB1}	High-Z	—
X	L	X	X	Standby	I_{SB}, I_{SB1}	High-Z	—
L	H	H	H	Output disable	I_{CC}	High-Z	—
L	H	L	H	Read	I_{CC}	Dout	Read cycle
L	H	H	L	Write	I_{CC}	Din	Write cycle (1)
L	H	L	L	Write	I_{CC}	Din	Write cycle (2)

Note: X: H or L

Absolute Maximum Ratings

Parameter	Symbol	Value	Unit
Supply voltage relative to V_{SS}	V_{CC}	-0.5 to +7.0	V
Voltage on any pin relative to V_{SS} ^{*1}	V_T	-0.5 ^{*2} to $V_{CC} + 0.3$ ^{*3}	V
Power dissipation	P_T	1.0	W
Operating temperature	T_{opr}	0 to +70	°C
Storage temperature	T_{stg}	-55 to +125	°C
Storage temperature under bias	T_{bias}	-10 to +85	°C

- Note: 1. With respect to V_{SS}
 2. -3.0 V for pulse half-width ≤ 30 ns
 3. Maximum voltage is 7.0V.

Recommended DC Operating Conditions ($T_a = 0$ to +70°C)

Parameter	Symbol	Min	Typ	Max	Unit
Supply voltage	V_{CC}	4.5	5.0	5.5	V
	V_{SS}	0	0	0	V
Input voltage (HM628128A-7/8/10)	V_{IH}	2.2	—	$V_{CC} + 0.3$	V
	V_{IL}	-0.3 ^{*1}	—	0.8	V
Input voltage (HM628128A-5)	V_{IH}	2.4	—	$V_{CC} + 0.3$	V
	V_{IL}	-0.3 ^{*1}	—	0.8	V

- Note: 1. -3.0 V for pulse half-width ≤ 30 ns

HM628128A Series

DC Characteristics ($T_a = 0$ to $+70^\circ\text{C}$, $V_{CC} = 5\text{ V} \pm 10\%$, $V_{SS} = 0\text{ V}$)

Parameter	Symbol	Min	Typ* ¹	Max	Unit	Test conditions
Input leakage current	$ I_{LI} $	—	—	1.0	μA	$V_{in} = V_{SS}$ to V_{CC}
Output leakage current	$ I_{LO} $	—	—	1.0	μA	$\overline{CS1} = V_{IH}$ or $CS2 = V_{IL}$ or $\overline{OE} = V_{IH}$ or $\overline{WE} = V_{IL}$, $V_{I/O} = V_{SS}$ to V_{CC}
Operating power supply current: DC	I_{CC}	—	15	30	mA	$\overline{CS1} = V_{IL}$, $CS2 = V_{IH}$, Others = V_{IH}/V_{IL} $I_{I/O} = 0\text{ mA}$
Operating power supply current	I_{CC1} (HM628128 A-7/8/10)	—	45	70	mA	Min cycle, duty = 100%, $\overline{CS1} = V_{IL}$, $CS2 = V_{IH}$, Others = V_{IH}/V_{IL} $I_{I/O} = 0\text{ mA}$
	I_{CC1} (HM628128 A-5)	—	50	80	mA	
	I_{CC2}	—	15	25	mA	
Standby power supply current: DC	I_{SB}	—	1	2	mA	(1) $\overline{CS1} = V_{IH}$, $CS2 = V_{IH}$ or (2) $CS2 = V_{IL}$
Standby power supply current (1): DC	I_{SB1} (L version)	—	2	100	μA	$0\text{ V} \leq V_{in} \leq V_{CC}$, (1) $\overline{CS1} \geq V_{CC} - 0.2\text{ V}$, $CS2 \geq V_{CC} - 0.2\text{ V}$ or (2) $0\text{ V} \leq CS2 \leq 0.2\text{ V}$
	I_{SB1} (L-L/L-SL version)	—	2	50	μA	
Output voltage	V_{OL}	—	—	0.4	V	$I_{OL} = 2.1\text{ mA}$
	V_{OH}	2.4	—	—	V	$I_{OH} = -1.0\text{ mA}$

Note: 1. Typical values are at $V_{CC} = 5.0\text{ V}$, $T_a = +25^\circ\text{C}$ and specified loading.

Capacitance ($T_a = 25^\circ\text{C}$, $f = 1.0\text{ MHz}$)*¹

Parameter	Symbol	Min	Typ	Max	Unit	Test conditions
Input capacitance	C_{in}	—	—	8	pF	$V_{in} = 0\text{ V}$
Input/output capacitance	$C_{I/O}$	—	—	10	pF	$V_{I/O} = 0\text{ V}$

Note: 1. This parameter is sampled and not 100% tested.

AC Characteristics ($T_a = 0$ to $+70^\circ\text{C}$, $V_{CC} = 5\text{ V} \pm 10\%$, unless otherwise noted.)

Test Conditions

- Input pulse levels: 0.8 V to 2.4 V (HM628128A-7/8/10)
0 V to 3 V (HM628128A-5)
- Input rise and fall times: 5 ns
- Input and output timing reference levels: 1.5 V
- Output load: 1 TTL Gate and CL (100 pF) (HM628128A-7/8/10)
1 TTL Gate and CL (30 pF) (HM628128A-5) (Including scope & jig)

Read Cycle

Parameter	Symbol	HM628128A								Unit	Notes
		-5		-7		-8		-10			
		Min	Max	Min	Max	Min	Max	Min	Max		
Read cycle time	t_{RC}	55	—	70	—	85	—	100	—	ns	
Address access time	t_{AA}	—	55	—	70	—	85	—	100	ns	
Chip selection to output valid	t_{CO1} t_{CO2}	—	55	—	70	—	85	—	100	ns	
Output enable to output valid	t_{OE}	—	30	—	35	—	45	—	50	ns	
Chip selection to output in low-Z	t_{LZ1} t_{LZ2}	5	—	10	—	10	—	10	—	ns	2, 3
Output enable to output in low-Z	t_{OLZ}	5	—	5	—	5	—	5	—	ns	2, 3
Chip deselection to output in high-Z	t_{HZ1} t_{HZ2}	0	20	0	25	0	30	0	35	ns	1, 2, 3
Output disable to output in high-Z	t_{OHZ}	0	20	0	25	0	30	0	35	ns	1, 2, 3
Output hold from address change	t_{OH}	5	—	10	—	10	—	10	—	ns	

HM628128A Series

Read Timing Waveform *4

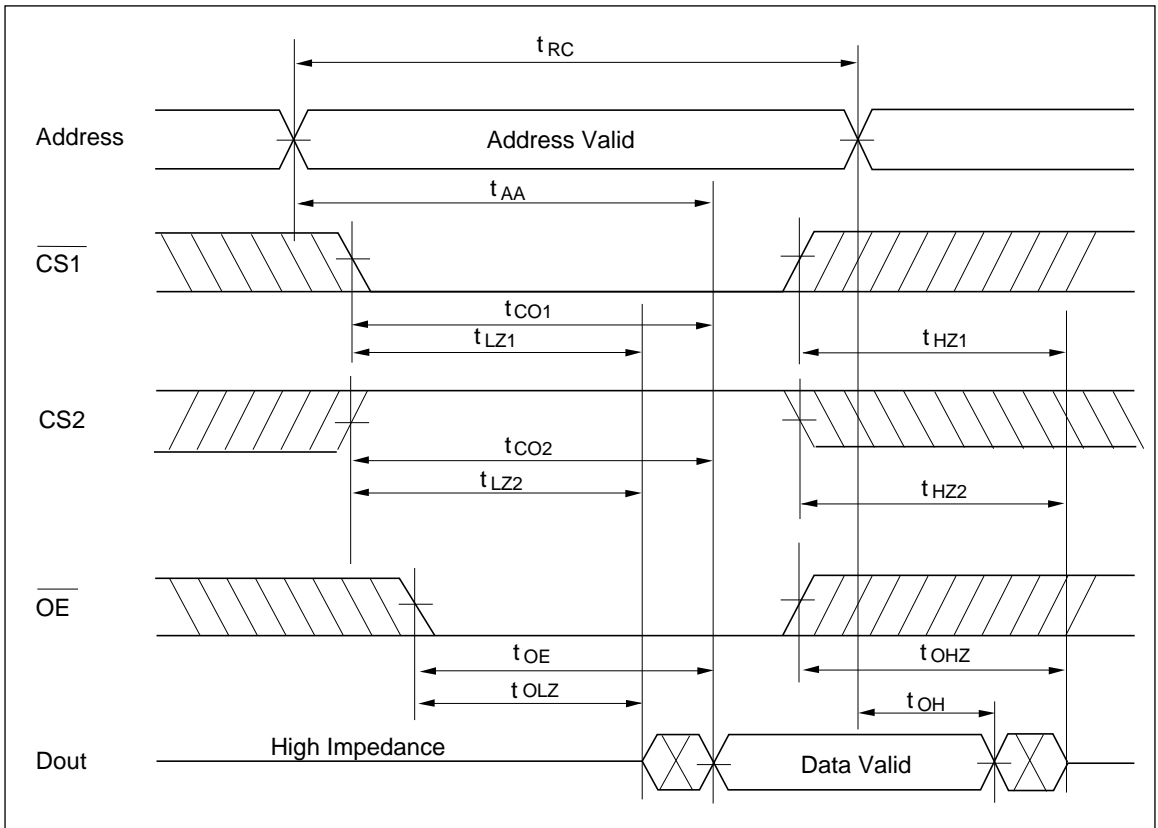

- Notes:
1. t_{HZ} and t_{OHZ} are defined as the time at which the outputs achieve the open circuit conditions and are not referred to output voltage levels.
 2. At any given temperature and voltage condition, t_{HZ} max is less than t_{LZ} min both for a given device and from device to device.
 3. This parameter is sampled and not 100% tested.
 4. \overline{WE} is high for read cycle.

Write Cycle

Parameter	Symbol	HM628128A								Unit	Notes
		-5		-7		-8		-10			
		Min	Max	Min	Max	Min	Max	Min	Max		
Write cycle time	t _{WC}	55	—	70	—	85	—	100	—	ns	
Chip selection to end of write	t _{CW}	50	—	60	—	75	—	80	—	ns	
Address setup time	t _{AS}	0	—	0	—	0	—	0	—	ns	
Address valid to end of write	t _{AW}	50	—	60	—	75	—	80	—	ns	
Write pulse width	t _{WP}	40	—	50	—	55	—	60	—	ns	
Write recovery time	t _{WR}	0	—	0	—	0	—	0	—	ns	
Write to output in high-Z	t _{WHZ}	0	20	0	25	0	30	0	35	ns	10
Data to write time overlap	t _{DW}	25	—	30	—	35	—	40	—	ns	
Data hold from write time	t _{DH}	0	—	0	—	0	—	0	—	ns	
Output active from end of write	t _{OW}	5	—	5	—	5	—	5	—	ns	10

HM628128A Series

Write Timing Waveform (1) ($\overline{\text{OE}}$ Clock)

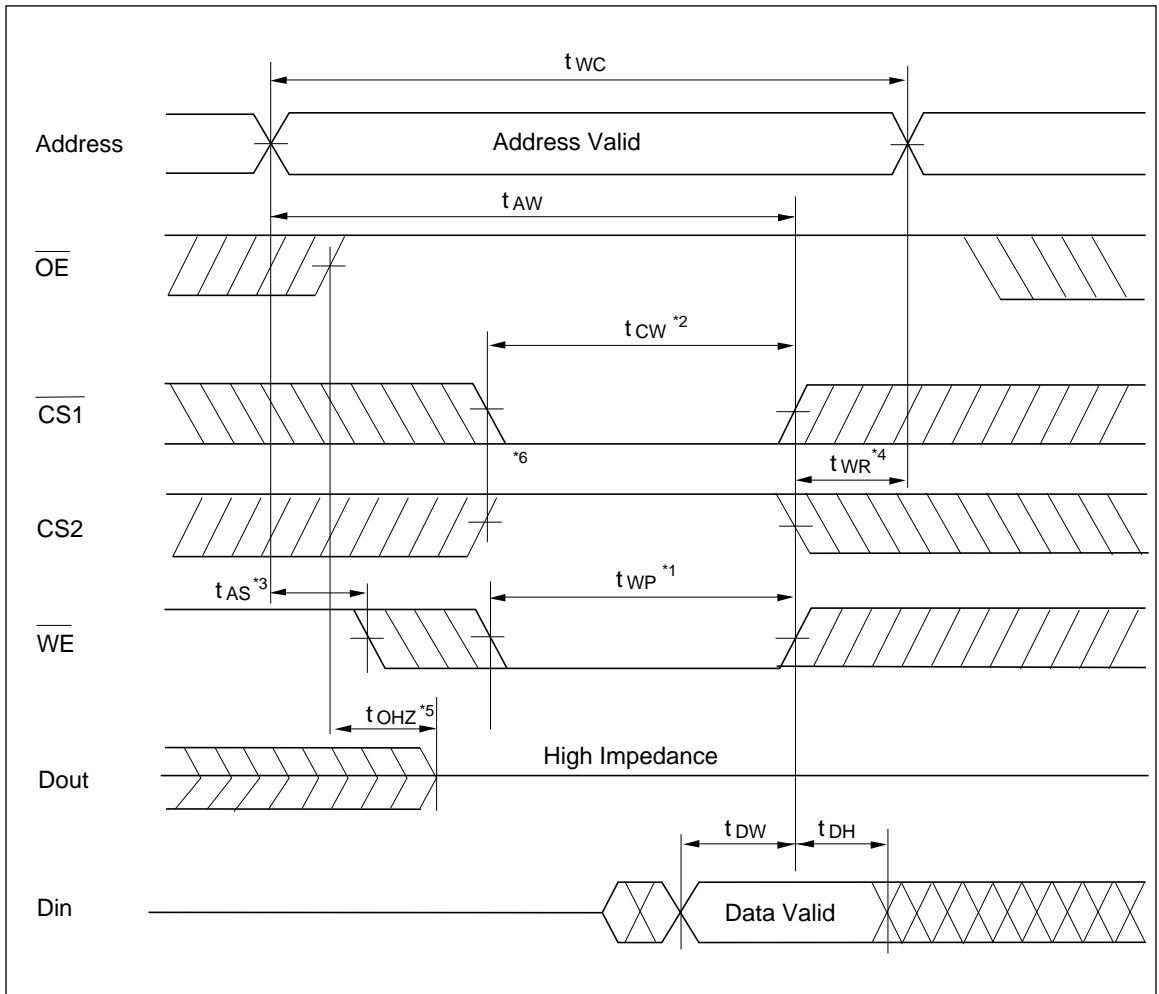

Write Timing Waveform (2) (\overline{OE} low Fixed)

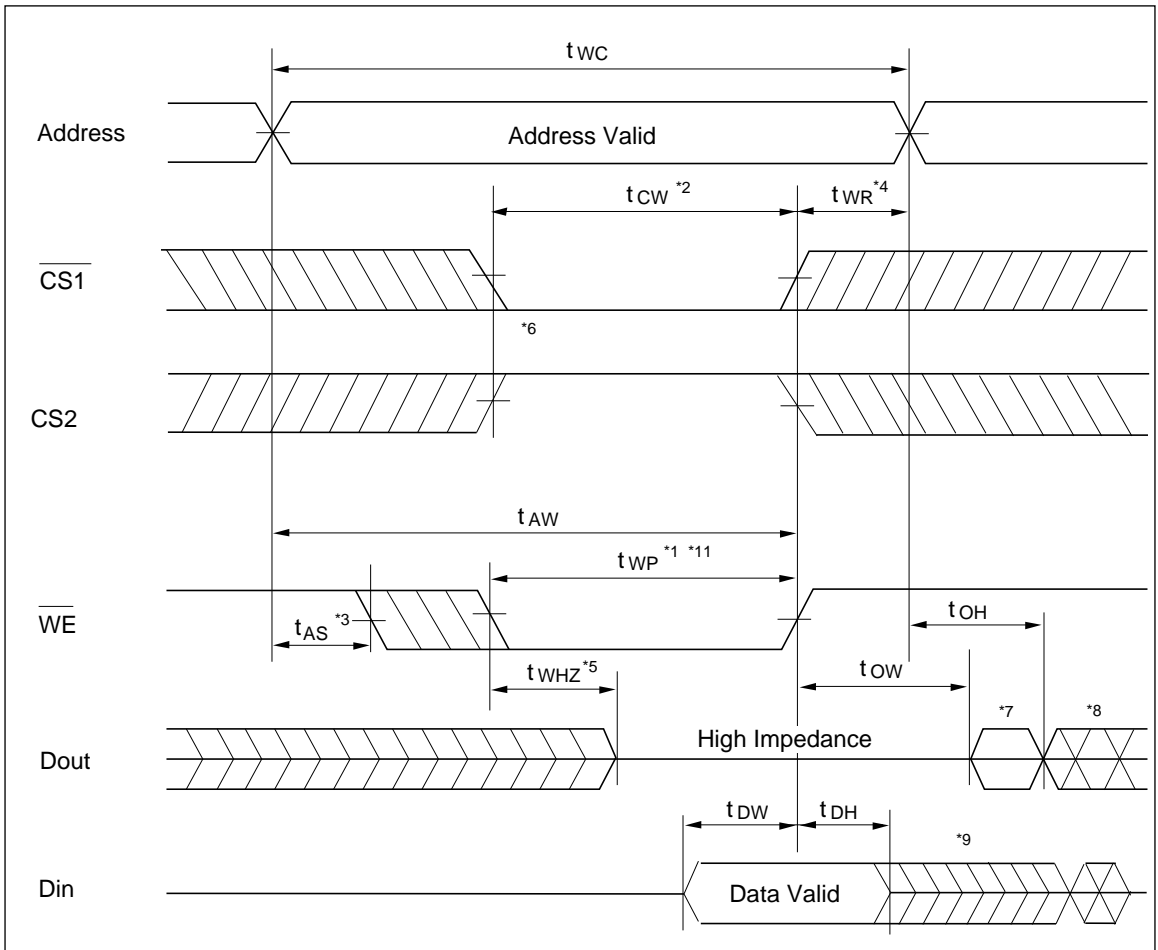

- Notes:
1. A write occurs during the overlap of a low $\overline{CS1}$, a high CS2, and a low \overline{WE} . A write begins at the latest transition among $\overline{CS1}$ going low, CS2 going high, and \overline{WE} going low. A write ends at the earliest transition among $\overline{CS1}$ going high, CS2 going low, and \overline{WE} going high. t_{WP} is measured from the beginning of write to the end of write.
 2. t_{CW} is measured from the later of $\overline{CS1}$ going low or CS2 going high to the end of write.
 3. t_{AS} is measured from the address valid to the beginning of write.
 4. t_{WR} is measured from the earliest of $\overline{CS1}$ or \overline{WE} going high or CS2 going low to the end of write cycle.
 5. During this period, I/O pins are in the output state; therefore, the input signals of the opposite phase to the outputs must not be applied.
 6. If the $\overline{CS1}$ goes low simultaneously with \overline{WE} going low or after the \overline{WE} going low, the outputs remain in a high impedance state.
 7. Dout is the same phase of the latest written data in this write cycle.
 8. Dout is the read data of next address.
 9. If $\overline{CS1}$ is low and CS2 high during this period, I/O pins are in the output state. Therefore, the input signals of opposite phase to the outputs must not be applied to them.
 10. This parameter is sampled and not 100% tested.
 11. In the write cycle with \overline{OE} low fixed, t_{WP} must satisfy the following equation to avoid a problem of

HM628128A Series

data bus contention.

$$t_{WP} \geq t_{DW \text{ min}} + t_{WHZ \text{ max}}$$

Low V_{CC} Data Retention Characteristics ($T_a = 0$ to $+70^\circ\text{C}$)

Parameter	Symbol	Min	Typ	Max	Unit	Test conditions*4
V_{CC} for data retention	V_{DR}	2.0	—	—	V	$\overline{CS1} \geq V_{CC} - 0.2 \text{ V}$, $CS2 \geq V_{CC} - 0.2 \text{ V}$ or $0 \text{ V} \leq CS2 \leq 0.2 \text{ V}$ $V_{in} > 0 \text{ V}$
Data retention current	I_{CCDR} (L version)	—	1	50^{*1}	μA	$V_{CC} = 3.0 \text{ V}$, $V_{in} \geq 0 \text{ V}$ $\overline{CS1} \geq V_{CC} - 0.2 \text{ V}$
	I_{CCDR} (L-L version)	—	1	30^{*2}	μA	$CS2 \geq V_{CC} - 0.2 \text{ V}$ or $0 \text{ V} \leq CS2 \leq 0.2 \text{ V}$
	I_{CCDR} (L-SL version)	—	1	15^{*3}	μA	
Chip deselect to data retention time	t_{CDR}	0	—	—	ns	See retention waveform
Operation recovery time	t_R	5	—	—	ms	

Low V_{CC} Data Retention Timing Waveform (1) ($\overline{CS1}$ Controlled)

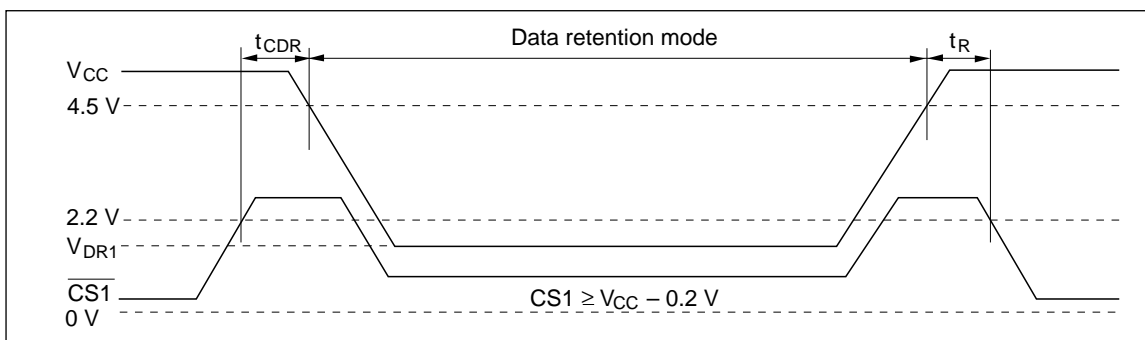

Low V_{CC} Data Retention Timing Waveform (2) ($CS2$ Controlled)

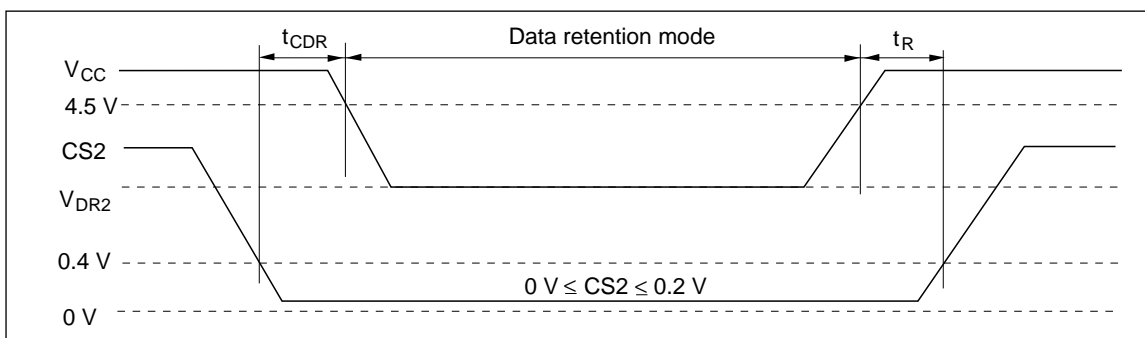

- Notes:
1. 20 μA max at $T_a = 0$ to 40°C (L-version).
 2. 6 μA max at $T_a = 0$ to 40°C (L-L-version).
 3. 3 μA max at $T_a = 0$ to 40°C (L-SL-version).
 4. CS2 controls address buffer, $\overline{\text{WE}}$ buffer, $\overline{\text{CS1}}$ buffer, $\overline{\text{OE}}$ buffer, and Din buffer. If CS2 controls data retention mode, Vin levels (address, $\overline{\text{WE}}$, $\overline{\text{OE}}$, $\overline{\text{CS1}}$, I/O) can be in the high impedance state. If $\overline{\text{CS1}}$ controls data retention mode, CS2 must be $\text{CS2} \geq V_{\text{CC}} - 0.2 \text{ V}$ or $0 \text{ V} \leq \text{CS2} \leq 0.2 \text{ V}$. The other input levels (address, $\overline{\text{WE}}$, $\overline{\text{OE}}$, I/O) can be in the high impedance state.