

### SILICON GATE CMOS

### 8,192 WORD x 8 BIT CMOS STATIC RAM

#### Description

The TC5588P/J is a 65,536 bit high speed CMOS static random access memory organized as 8,192 words by 8 bits and operated from a single 5V supply. Toshiba's advanced CMOS technology and circuit design enable high speed operation.

The TC5588P/J features low power dissipation when the device is deselected using chip enable ( $\overline{CE1}$ , CE2) and has an output enable input ( $\overline{OE}$ ) for fast memory access. Also, the device power between memory accesses is reduced by an automatic power down circuit.

The TC5588P/J is suitable for use in high speed applications such as cache memory and high speed storage. All inputs and outputs are TTL compatible. The TC5588P/J is available in a 300mil width, 28-pin DIP and SOJ suitable for high density surface assembly.

#### Features

- Fast access time
  - TC5588P/J-15 15ns (max.)
  - TC5588P/J-20 20ns (max.)
  - TC5588P/J-25 25ns (max.)
  - TC5588P/J-35 35ns (max.)
- Low power dissipation
  - Operation:
    - TC5588P/J-15 135mA (max.)
    - TC5588P/J-20 115mA (max.)
    - TC5588P/J-25 115mA (max.)
    - TC5588P/J-35 115mA (max.)
  - Standby: 1mA (max.)
- Single 5V power supply:  $5V \pm 10\%$
- Fully static operation
- Inputs and outputs TTL compatible
- Output buffer control:  $\overline{OE}$
- Package:
  - TC5588P: DIP28-P-300B
  - TC5588J: SOJ28-P-300A

#### Pin Connection (Top View)

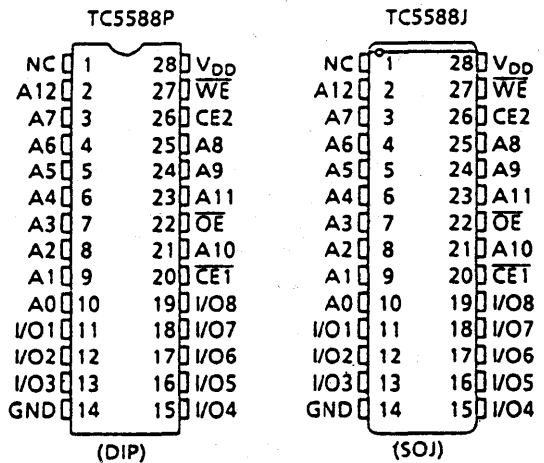

#### Pin Names

A0 ~ A12	Address Inputs
I/O1 ~ I/O8	Data Inputs/Outputs
$\overline{CE1}$ , CE2	Chip Enable Inputs
$\overline{WE}$	Write Enable Input
$\overline{OE}$	Output Enable Input
V <sub>DD</sub>	Power (+5V)
GND	Ground
NC	No Connection

Block Diagram

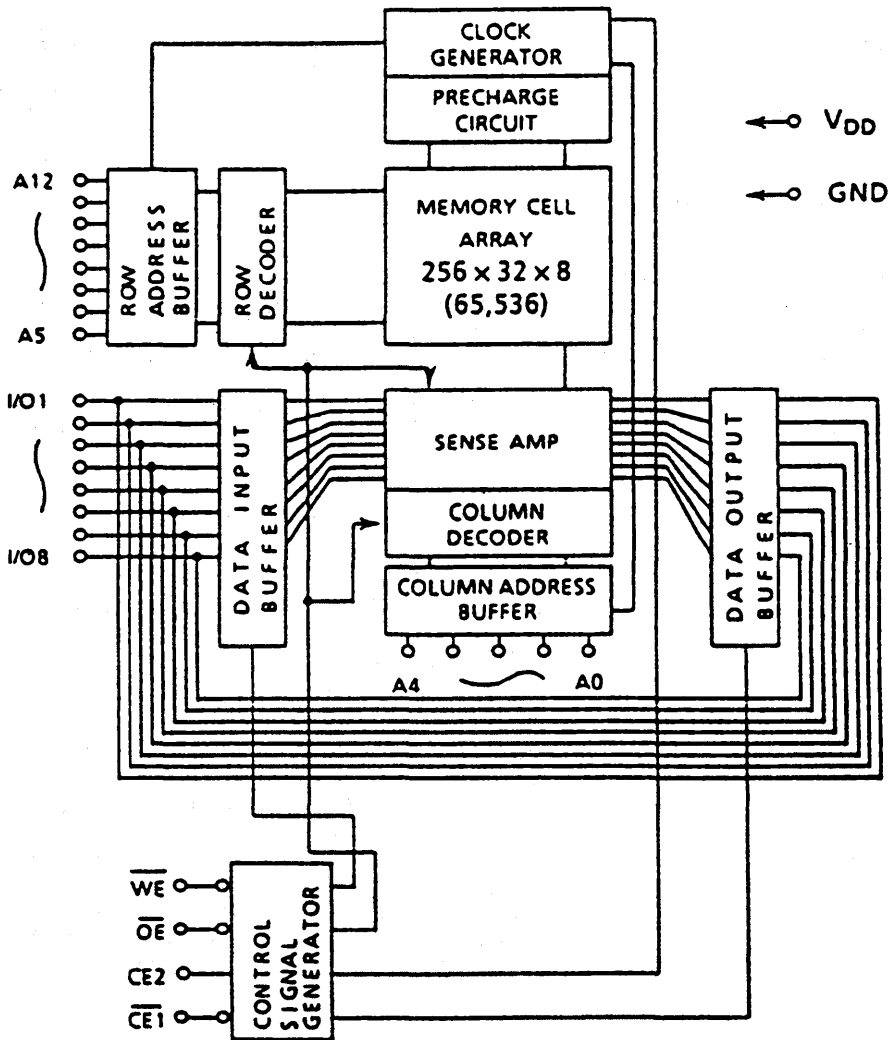

Maximum Ratings

SYMBOL	ITEM	RATING	UNIT
V <sub>DD</sub>	Power Supply Voltage	-0.5 ~ 7.0	V
V <sub>IN</sub>	Input Voltage	-2.0 ~ 7.0	V
V <sub>IO</sub>	Input/Output Voltage	-0.5 ~ V <sub>DD</sub> + 0.5	V
P <sub>D</sub>	Power Dissipation	1.0	W
T <sub>SOLDER</sub>	Soldering Temperature • Time	260 • 10	°C • sec
T <sub>STRG</sub>	Storage Temperature	-65 ~ 150	°C
T <sub>OPR</sub>	Operating Temperature	-10 ~ 85	°C

## DC Recommended Operating Conditions

SYMBOL	PARAMETER	MIN.	TYP.	MAX.	UNIT
$V_{DD}$	Power Supply Voltage	4.5	5.0	5.5	V
$V_{IH}$	Input High Voltage	2.2	—	$V_{DD} + 0.5$	V
$V_{IL}$	Input Low Voltage	-0.5*	—	0.8	V

\* -3V with a pulse width of 10ns

DC Characteristics ( $T_a = 0 \sim 70^\circ\text{C}$ ,  $V_{DD} = 5V \pm 10\%$ )

SYMBOL	PARAMETER	TEST CONDITION	MIN.	TYP.	MAX.	UNIT	
$I_{LI}$	Input Leakage Current	$V_{IN} = 0 \sim V_{DD}$	—	—	$\pm 1$	$\mu\text{A}$	
$I_{LO}$	Output Leakage Current	$\overline{CE1} = V_{IH}$ or $CE2 = V_{IL}$ or $\overline{WE} = V_{IL}$ or $\overline{OE} = V_{IH}$ , $V_{OUT} = 0 \sim V_{DD}$	—	—	$\pm 1$	$\mu\text{A}$	
$I_{OH}$	Output High Current	$V_{OH} = 2.4V$	-4	—	—	mA	
$I_{OL}$	Output Low Current	$V_{OL} = 0.4V$	8	—	—	mA	
$I_{DDO}$	Operating Current	$V_{DD} = 5.5V$ $t_{\text{cycle}} = \text{Min cycle}$ $\overline{CE1} = V_{IL}$ and $CE2 = V_{IH}$ Other Inputs = $V_{IH}/V_{IL}$ $I_{OUT} = 0\text{mA}$	-15	—	—	135	mA
			-20	—	—	—	
			-25	—	—	115	
			-35	—	—	—	
$I_{DDs1}$	Standby Current	$V_{DD} = 5.5V$ $t_{\text{cycle}} = \text{Min cycle}$ $\overline{CE1} = V_{IH}$ or $CE2 = V_{IL}$ Other Inputs = $V_{IH}/V_{IL}$	—	—	—	25	mA
$I_{DDs2}^*$		$\overline{CE1} = V_{DD} - 0.2V$ or $CE2 = 0.2V$ Other Inputs = $V_{DD} - 0.2V$ or $0.2V$	—	—	—	1	

\* If  $\overline{CE1} \geq V_{DD} - 0.2V$ , the specified limits are guaranteed under the condition  $CE2 \geq V_{DD} - 0.2V$  or  $CE2 \leq 0.2V$ .

Capacitance\* ( $T_a = 25^\circ\text{C}$ ,  $f = 1.0\text{MHz}$ )

SYMBOL	PARAMETER	TEST CONDITION	MAX.	UNIT
$C_{IN}$	Input Capacitance	$V_{IN} = \text{GND}$	5	pF
$C_{OUT}$	Output Capacitance	$V_{OUT} = \text{GND}$	7	pF

\*This parameter is periodically sampled and is not 100% tested.

AC Characteristics ( $T_a = 0 \sim 70^\circ\text{C}^{(1)}$ ,  $V_{DD} = 5V \pm 10\%$ )

## Read Cycle

SYMBOL	PARAMETER	TC5588P/J-15		TC5588P/J-20		TC5588P/J-25		TC5588P/J-35		UNIT
		MIN.	MAX.	MIN.	MAX.	MIN.	MAX.	MIN.	MAX.	
$t_{RC}$	Read Cycle Time	15	-	20	-	25	-	35	-	ns
$t_{ACC}$	Address Access Time	-	15	-	20	-	25	-	35	
$t_{CO1}$	$\overline{CE1}$ Access Time	-	15	-	20	-	25	-	35	
$t_{CO2}$	CE2 Access Time	-	15	-	20	-	25	-	35	
$t_{OE}$	$\overline{OE}$ Access Time	-	9	-	10	-	12	-	12	
$t_{OH}$	Output Data Hold Time from Address Change	5	-	5	-	5	-	5	-	
$t_{COE}$	Output Enable Time from $\overline{CE1}$ or CE2	5	-	5	-	5	-	5	-	
$t_{COD}$	Output Disable Time from $\overline{CE1}$ or CE2	-	6	-	6	-	6	-	6	
$t_{OEE}$	Output Enable Time from $\overline{OE}$	0	-	0	-	0	-	0	-	
$t_{ODO}$	Output Disable Time from $\overline{OE}$	-	5	-	5	-	5	-	5	
$t_{PU}$	Chip Selection to Power Up Time	0	-	0	-	0	-	0	-	
$t_{PD}$	Chip Deselection to Power Down Time	-	15	-	20	-	25	-	35	

## Write Cycle

SYMBOL	PARAMETER	TC5588P/J-15		TC5588P/J-20		TC5588P/J-25		TC5588P/J-35		UNIT
		MIN.	MAX.	MIN.	MAX.	MIN.	MAX.	MIN.	MAX.	
$t_{WC}$	Write Cycle Time	15	-	20	-	25	-	35	-	ns
$t_{CW}$	Chip Enable to End of Write	12	-	13	-	15	-	15	-	
$t_{AS}$	Address Setup Time	0	-	0	-	0	-	0	-	
$t_{WP}$	Write Pulse Width	12	-	13	-	15	-	15	-	
$t_{WR}$	Write Recovery Time	0	-	0	-	0	-	0	-	
$t_{DS}$	Data Setup Time	9	-	10	-	12	-	12	-	
$t_{DH}$	Data Hold Time	0	-	0	-	0	-	0	-	
$t_{OEW}$	Output Enable Time from $\overline{WE}$	0	-	0	-	0	-	0	-	
$t_{ODW}$	Output Disable Time from $\overline{WE}$	-	6	-	6	-	6	-	6	

## AC Test Conditions

Input Pulse Levels	3.0V/0.0V
Input Pulse Rise and Fall Time	3ns
Input Timing Measurement Reference Levels	2.2V/0.8V
Output Timing Measurement Reference Levels	2.0V/0.8V
Output Load	Fig. 1

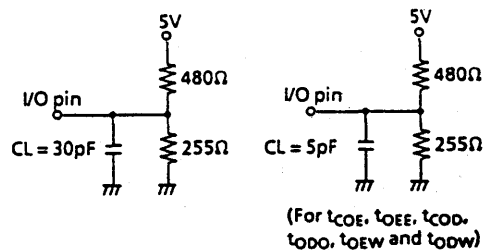
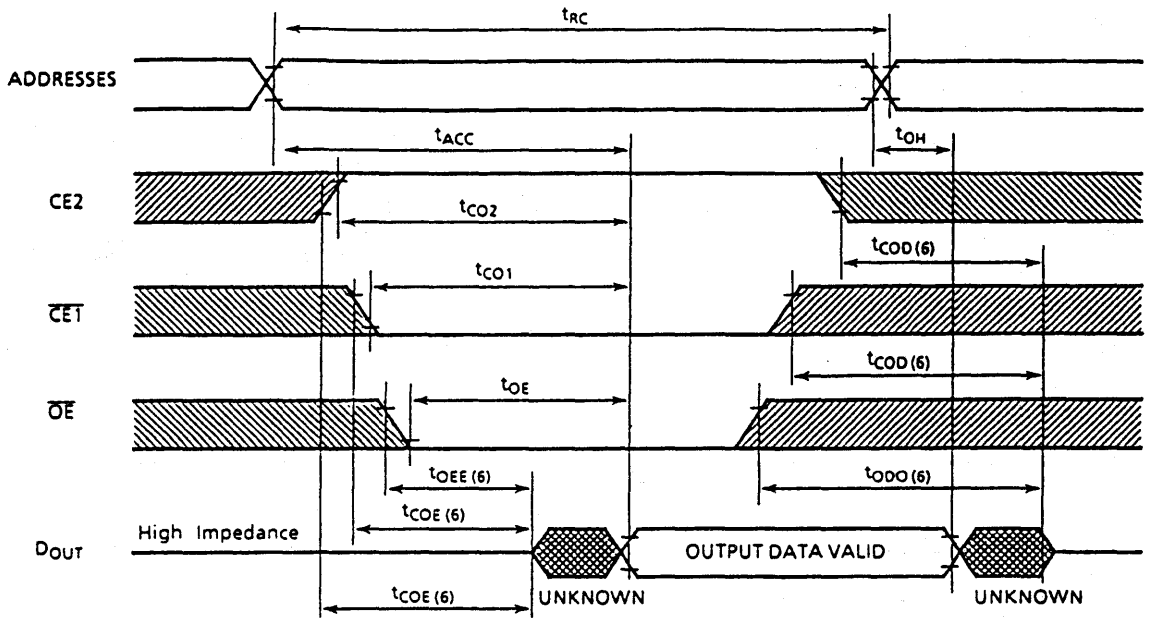

Figure 1.

Timing Waveforms

Read Cycle <sup>(2)</sup>



Write Cycle 1 <sup>(5)</sup> ( $\overline{WE}$  Controlled Write)

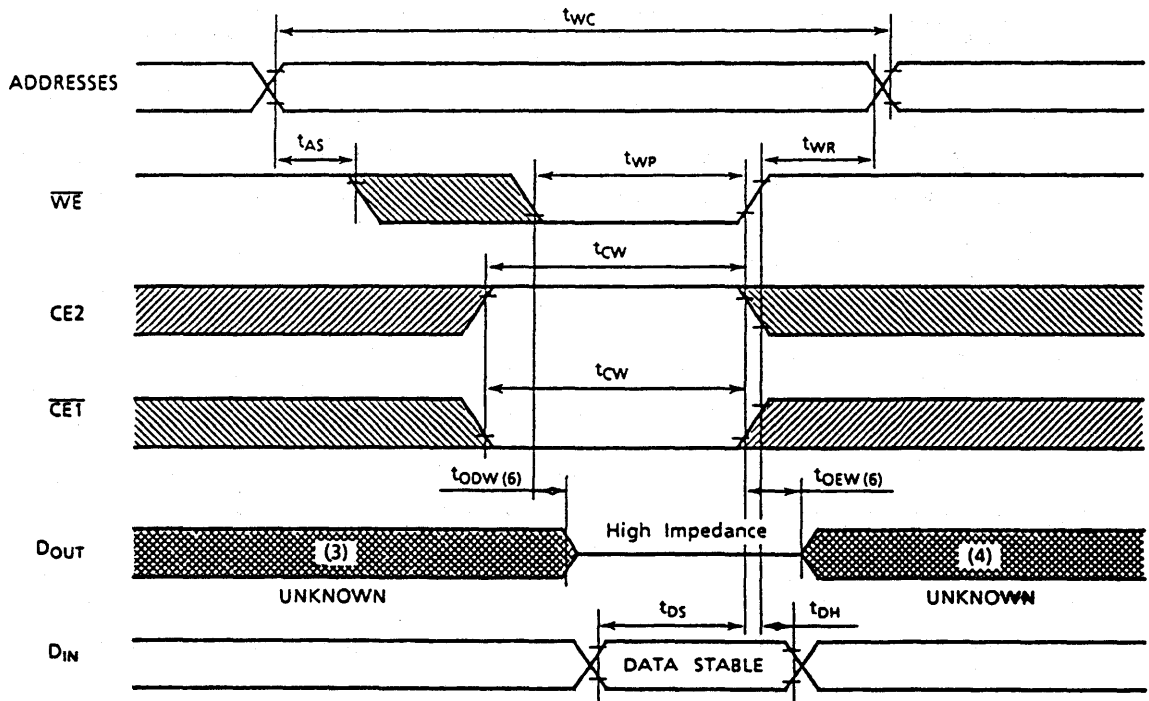

Write Cycle 2 <sup>(5)</sup> ( $\overline{CE1}$  Controlled Write)

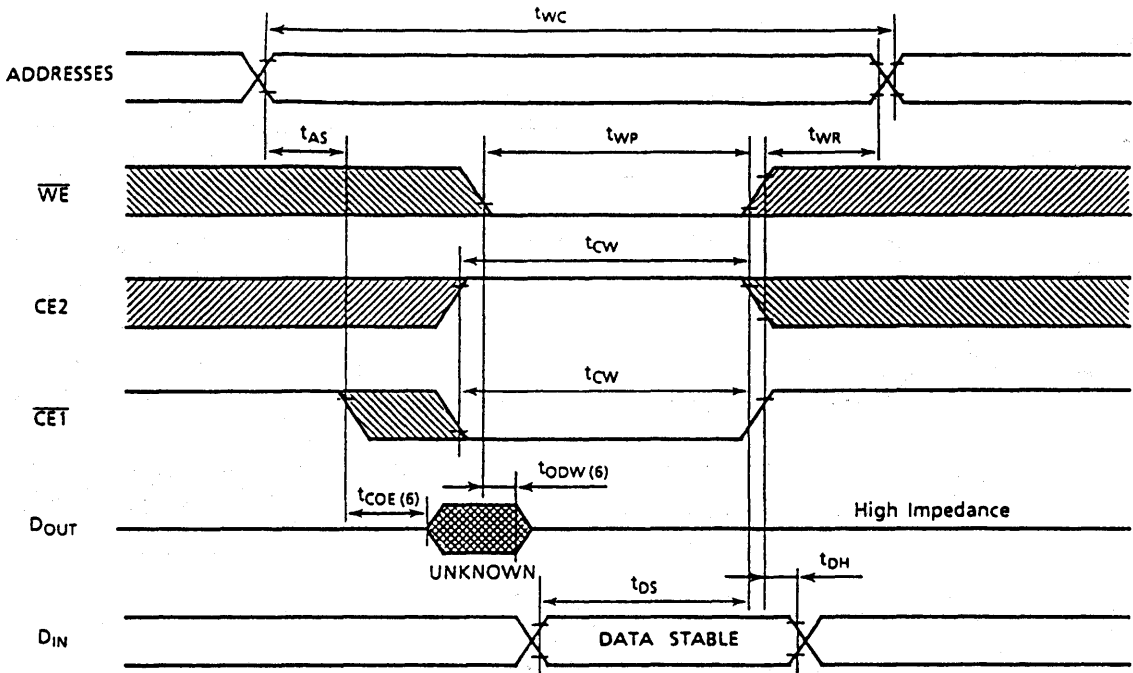

Write Cycle 3 <sup>(5)</sup> ( $\overline{CE2}$  Controlled Write)

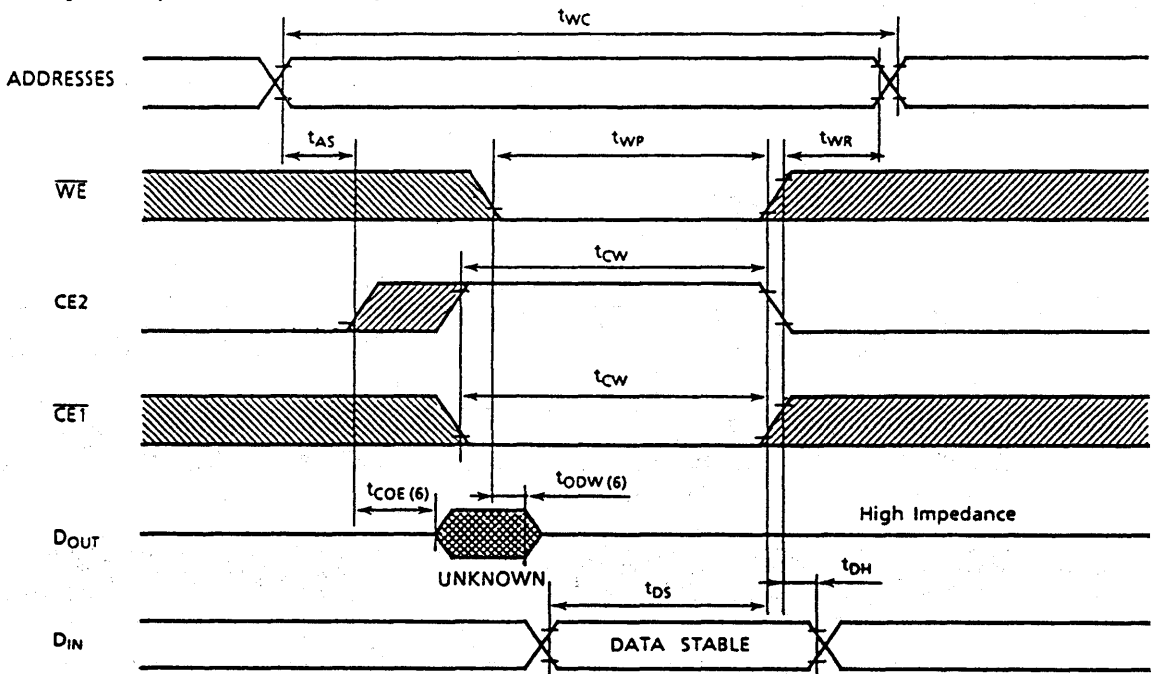

Notes:

1. The operating temperature ( $T_a$ ) is guaranteed with transverse air flow exceeding 400 linear feet per minute.
2.  $\overline{WE}$  is high for read cycles.
3. If the  $\overline{CE1}$  low transition or CE2 high transition occurs coincident with or after the  $\overline{WE}$  low transition, outputs remain in a high impedance state.
4. If the  $\overline{CE1}$  high transition or CE2 low transition occurs coincident with or prior to the  $\overline{WE}$  high transition, outputs remain in a high impedance state.
5. If  $\overline{OE}$  is high during a write cycle, the outputs are in a high impedance state during this period.
6. The following parameters are measured using the load shown in Fig. 1.
  - (A)  $t_{COE}$ ,  $t_{OEE}$ ,  $t_{OEW}$  . . . . . Output Enable Time
  - (B)  $t_{COD}$ ,  $t_{ODO}$ ,  $t_{ODW}$  . . . . . Output Disable Time

