



A

Pushbutton



## Features/Benefits

- Up to 10 poles per module
- Various contact terminals
- Various mounting & switch ganging configurations
- Mechanical indicator buttons
- Illumination options

## Typical Applications

- Audio selection
- Digital equipment interface
- Medical equipment interface

## Specifications

SWITCHING POWER: F module max. AC/DC: Silver: 50 VA/15W, Gold: 1 VA/300 mW.

SWITCHING VOLTAGE: F module max. AC/DC: Silver: 125/30V, Gold: 50/30 V.

SWITCHING CURRENT: F module max. AC/DC: Silver: 0.5A/0.5A, Gold: 0.04A/0.01A.

CARRYING CURRENT: Max at  $\Delta u = 20C$ : Silver: < 2A, Gold: <0.5A.

DIELECTRIC STRENGTH (50 Hz, 1 min.): Chassis/contact:  $\wedge 1500V$  Between contacts:  $\wedge 1500V$

OPERATING LIFE "OA/EE" (24V/200mA):  $>10^5$  operations "GR":  $>3.5 \times 10^4$  operations.

CONTACT RESISTANCE: Initial: Typical  $\% 10 \text{ m}\Omega$ , max. 20  $\text{m}\Omega$  After operating life:  $\% 100 \text{ m}\Omega$

INSULATION RESISTANCE:  $\wedge 10^9 \Omega$  between open contacts,  $\wedge 10^9 \Omega$  between chassis and contacts.

CAPACITANCE (at  $f = 10 \text{ kHz}$ ):  $\% 0.7 \text{ pF}$  between 2 contacts.

TOTAL TRAVEL/LATCHING TRAVEL: 4.7mm/3.3mm (.185 inch/.130 inch)

NOTE: Specifications and materials listed above are for switches with standard options. For information on specific and custom switches, consult Customer Service Center.

TYPICAL F OPERATING FORCE: 2U: 6.5N (650 grams); 4U: 6.5N (650 grams); 6U: 7.5N (750 grams); 8U: 9.0N (900 grams); 10U: 9.0N (900 grams).

EUROPEAN TYPICAL SF OPERATING FORCE:

2U:  $3.5N \pm 0.5N$  (350 grams  $\pm 100$  grams); 4U:  $5N \pm 1N$  (500 grams  $\pm 100$  grams); 6U:  $6.5N \pm 1N$  (650 grams  $\pm 100$  grams); 8U:  $9.0N \pm 1N$  (900 grams  $\pm 100$  grams).

## Materials

HOUSING: Polycarbonate UL 94V-0 or polyester UL 94V-0.

ACTUATOR: Polyester UL 94V-0.

MOVABLE CONTACTS: Bimetal brass, silver plated, gold plate over nickel.

STATIONARY CONTACTS & TERMINALS: Brass, silver plated, gold plated.

TERMINAL BOARD: Polyester UL 94V-0.

RETURN SPRING: Music wire.

TERMINAL SEAL: RTV adhesive sealant.

CHASSIS: Steel.

LOCKOUT PIN: Steel.

BLOCKERS: Steel.

## Build-A-Switch

To order, simply select desired option from each category and place in the appropriate box. Available options are shown and described on pages A-88 thru A-96. For additional options not shown in catalog, consult Customer Service Center.

If requesting only a switch, select either a North American or European switch as noted below. Chassis and buttons are sold separately. If multiple stations are selected, we will assume all switches are the same unless noted otherwise.

## North American Order Code - Switch Only



### Designation

- F** (STD.) F Series
- FLT** Light touch F series
- ZF** Central mounted F series

### Contact Arrangement

- 2U** 2PDT
- 4U** 4PDT
- 6U** 6PDT
- 8U** 8PDT
- 10U** 10PDT

### Mechanical Function

- OA** Momentary
- EE** Alternate (push-push)
- GR** Interlock
- AOR** Central release
- OASP** Momentary with lockout
- GRSP** Interlock with lockout

### Terminal Sealing

- (NONE)** (STD.) None
- TB** Top/bottom

### Terminal Style

- (NONE)** (STD.) Solder lugs & PC pins
- 01A** Cut solder lugs
- 01B** Cut PC pins, for other configurations, consult factory

### Electrical Function

- (NONE)** (STD.) BBM
- M** MBB (special)

### Contact Material

- (NONE)** (STD.) Silver, AG
- AU** Gold

### Dress nut\*

\*Central mounted F series only

- (NONE)** (STD.) No dress nut
- B** Black
- C** Chrome

# C&K F Series Pushbutton Switches

## European Order Code - Switch Only

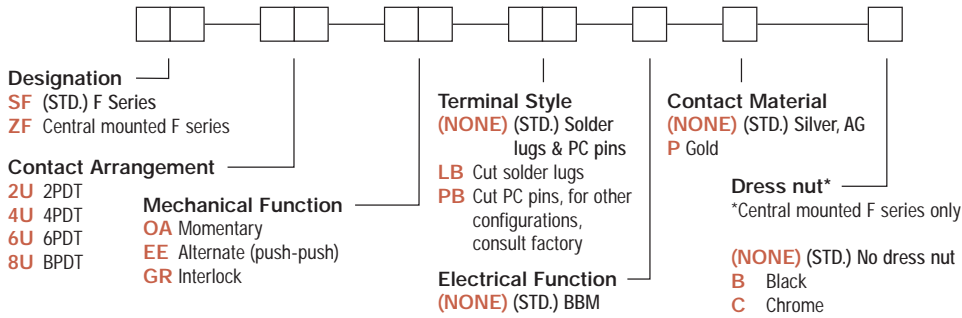

\*Minimum order quantities apply.

## Order Code - Buttons

### Solid Buttons

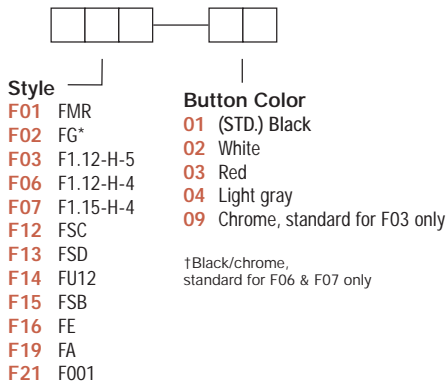

### Illuminated Buttons with Chassis

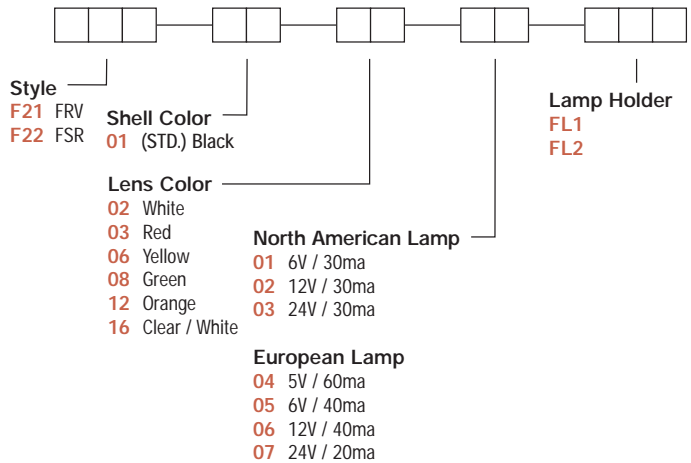

### Mechanical Indicator Buttons

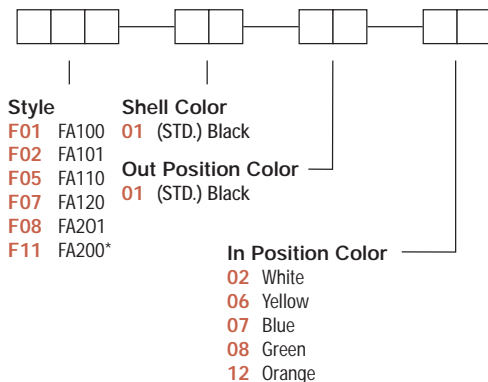

### Central Mounted Illuminated Buttons

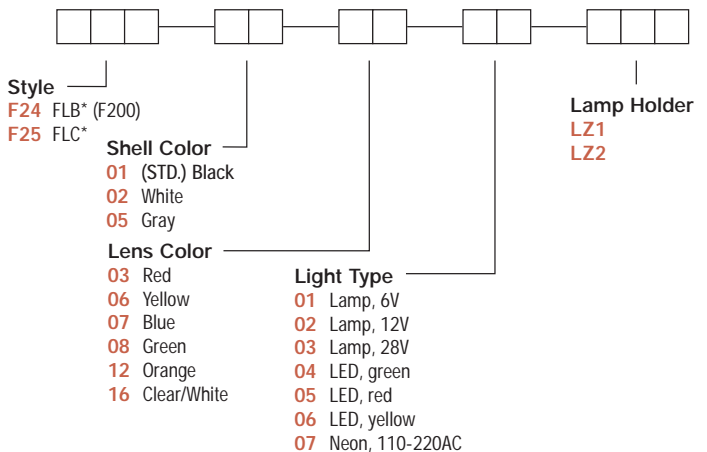

\*Button options for central mounting configurations, use 'FG' for central mount with chrome dress nut, use 'FA200', 'FLB' or 'FLC' for central mount with black dress nut.

## BUTTON REMOVAL

A button of a push-push switch should only be removed in the "OFF" non-latching position.



A

Pushbutton

## Order Code - Chassis

To order a switch with chassis, create the switch part number listed above and add the Chassis part number configurator information at the end of the part number.

Note: We do not guarantee or recommend interlocking beyond 10 stations.

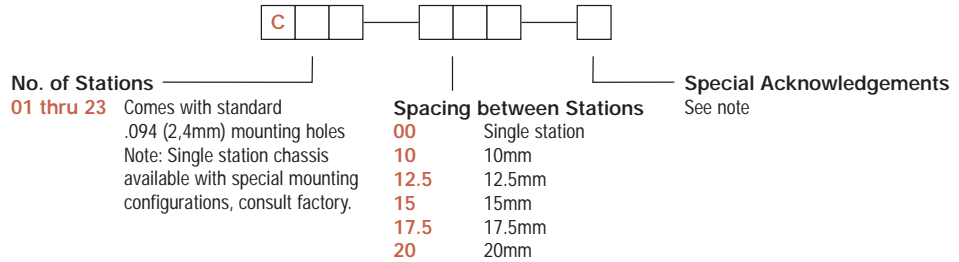

\*Minimum order quantities apply.

## SWITCHES WITH STANDARD OPTIONS

### F2UEE

CONTACT ARRANGEMENT	LENGTH DIM 'L'
2U	0.827 (21,00)
4U	1.300 (33,00)
6U	1.770 (45,00)
8U	2.240 (57,00)
10U	2.720 (69,00)

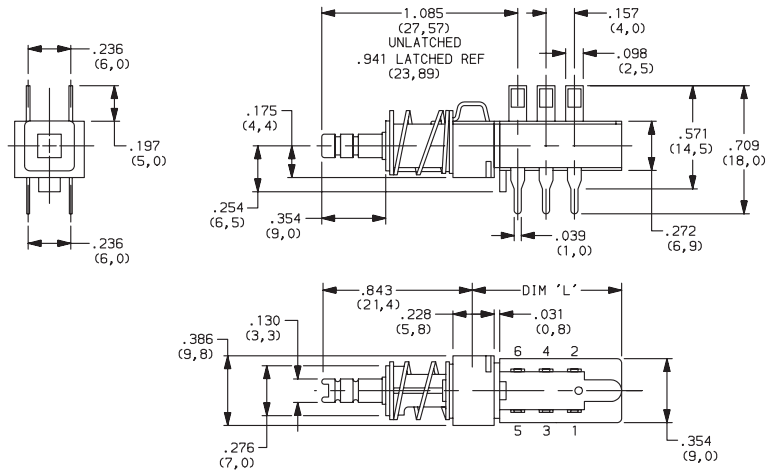

### ZF2UEEBF25010802LZ1

CONTACT ARRANGEMENT	LENGTH DIM 'L'
2U	0.827 (21,00)
4U	1.300 (33,00)
6U	1.770 (45,00)
8U	2.240 (57,00)
10U	2.720 (69,00)

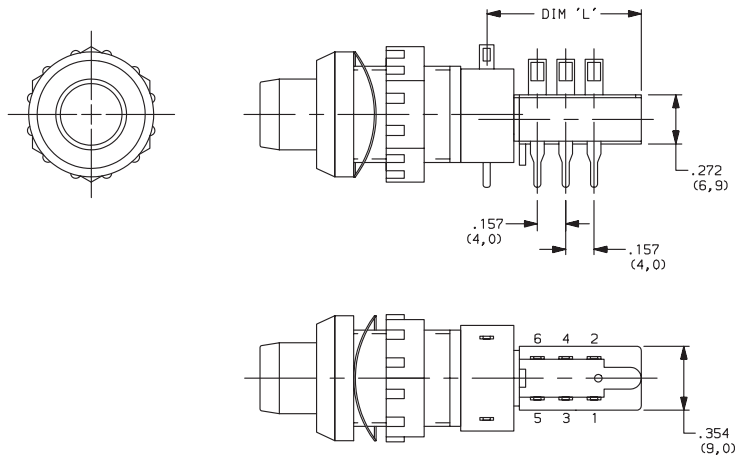

# C&K F Series Pushbutton Switches

A



Pushbutton

## DESIGNATION

**Designation, North America**  
**F** (STD.) F Series  
**FLT** Light touch F series  
**ZF** Central mounted F series

**Designation, Europe**  
**SF** (STD.) F Series  
**ZF** Central mounted F series

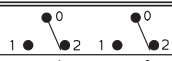
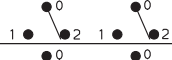
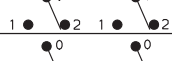
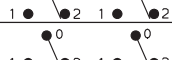
## CONTACT ARRANGEMENT

OPTION CODE	NO. OF POLES	SCHEMATIC
<b>2U</b>	2PDT	
<b>4U</b>	4PDT	2X 
<b>6U</b>	6PDT	3X 
<b>8U</b>	8PDT	4X 
<b>10U</b>	10PDT	5X 

### PC MOUNTING

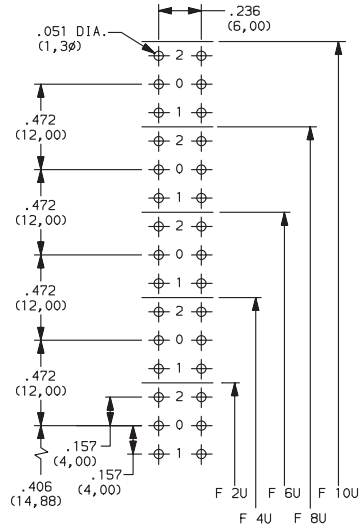

## MECHANICAL FUNCTION

### North America

OPTION CODE	FUNCTION
<b>OA</b>	Momentary
<b>EE</b>	Alternate (push-push)
<b>GR</b>	Interlock
<b>AOR</b>	Central release
<b>OASP</b>	Momentary with lockout
<b>GRSP</b>	Interlock with lockout

### Europe

OPTION CODE	FUNCTION
<b>OA</b>	Momentary
<b>EE</b>	Alternate (push-push)
<b>GR</b>	Interlock

## TERMINAL SEALING

**(NONE)** (STD.) NO SEAL

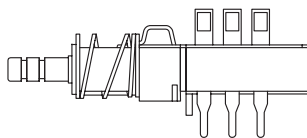

F2UEE shown in example above.

**TB** TOP & BOTTOM

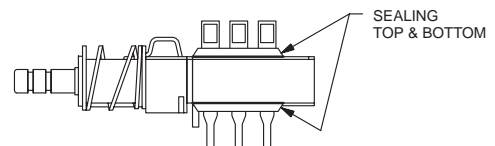

NOTE: Available for North America only



Dimensions are shown: IN (mm)  
 Dimensions subject to change

# C&K F Series Pushbutton Switches



A

Pushbutton

## TERMINAL STYLE



**(NONE)** (STD.) SOLDER LUGS & PC PINS

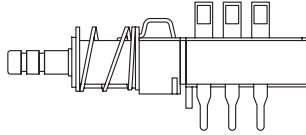

**01A** CUT SOLDER LUGS (North America)  
**LB** CUT SOLDER LUGS (Europe)

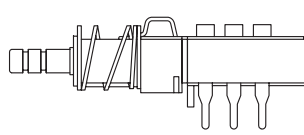

**01B** CUT PC PINS (North America)  
**PB** CUT PC PINS (Europe)

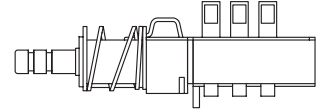

## ELECTRICAL FUNCTION



OPTION CODE	FUNCTION
<b>(NONE)</b> (STD.)	BBM Non-shorting
<b>M</b>	MBB Shorting (North America only)

## CONTACT MATERIAL



NORTH AMERICA OPTION CODE	EUROPE OPTION CODE	MATERIAL	RATING
<b>(NONE)</b> (STD.)	<b>(NONE)</b> (STD.)	Silver, AG	50 VA/15 W; 125/30 V; 0.5/0.5 A
<b>AU</b>	<b>P</b>	GOLD	1 VA/300mW; 50/30 V; 0.04 A/0.01 A

## DRESS NUT



**(NONE)** (STD.) NO DRESS NUT FOR F & F/LT DESIGNATIONS

**B** BLACK

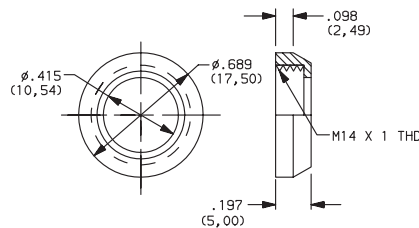

PANEL CUTOUT

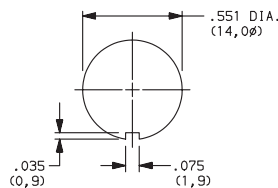

NOTE: Available with ZF designation and FA200, FLB or FLC buttons.

**C** CHROME

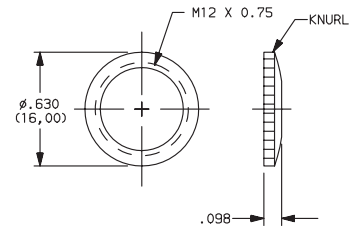

PANEL CUTOUT

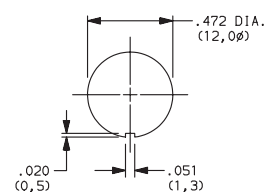

NOTE: Available with ZF designation and FG button.



Dimensions are shown: IN (mm)  
Dimensions subject to change

# C&K F Series Pushbutton Switches



A

Pushbutton

## SOLID BUTTON

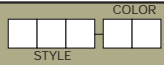

### STYLE

**F01** FMR

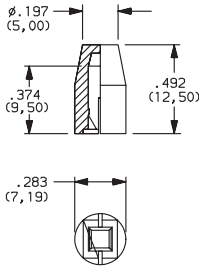

**F02** FG

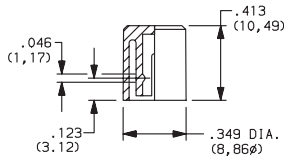

**F12** FSC

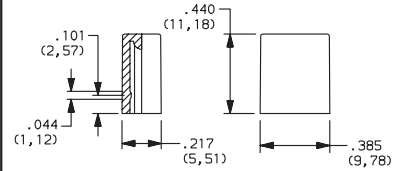
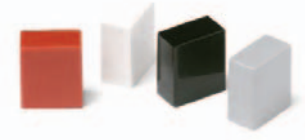

**F13** FSD

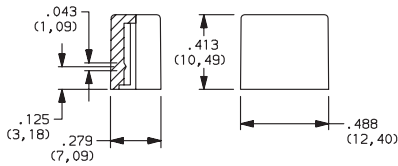
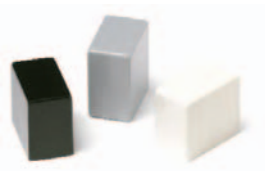

**F14** FU12

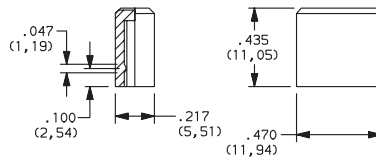
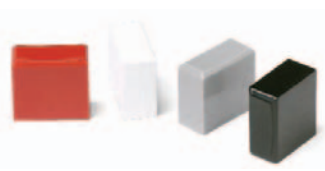

**F03** F1.12-H-5

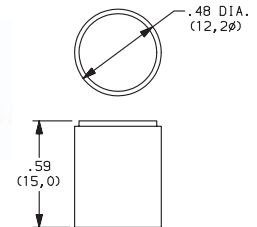

**F06** F1.12-H-4

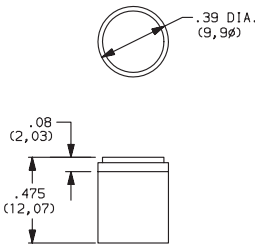

**F07** F1.15-H-4

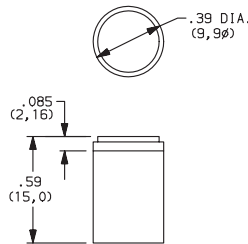

OPTION CODE	COLOR
01	(STD.) BLACK
02	WHITE
03	RED
04	LT. GRAY
09	BLACK/CHROME (F03, F06 & F07 buttons only)

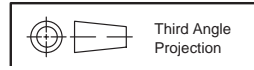

Dimensions are shown: IN (mm)  
Dimensions subject to change

# C&K F Series Pushbutton Switches



A

Pushbutton

## SOLID BUTTON

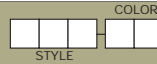

### STYLE

**F15** FSB

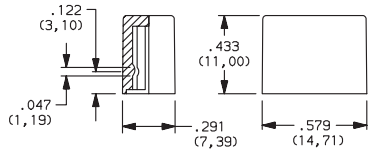
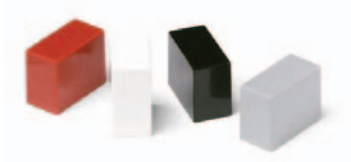

**F16** FE

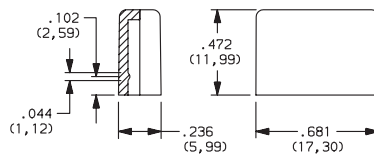

**F19** FA

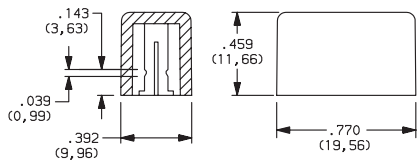

**F21** F001

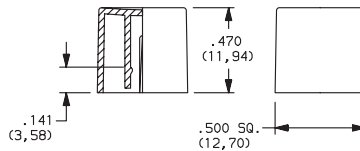
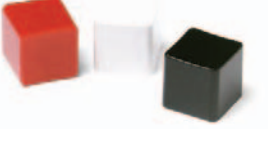

OPTION CODE	COLOR
01	(STD.) BLACK
02	WHITE
03	RED
04	LT. GRAY

## MECHANICAL BUTTON

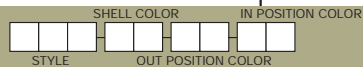

### STYLE

**F01** FA100

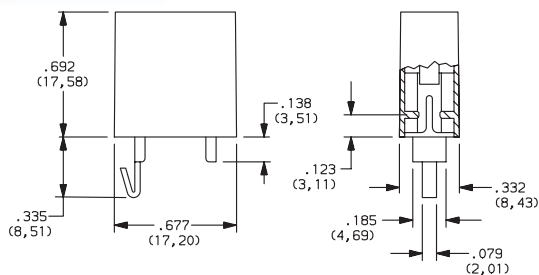

**F02** FA101

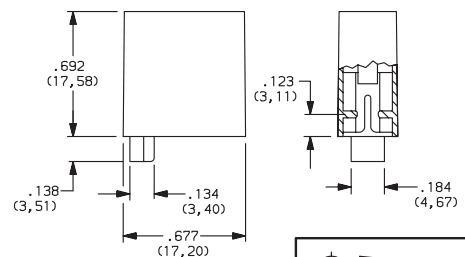

Dimensions are shown: IN (mm)  
Dimensions subject to change

# C&K F Series Pushbutton Switches

A

Pushbutton

## MECHANICAL BUTTON

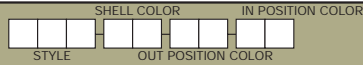

### STYLE

**F05** FA110

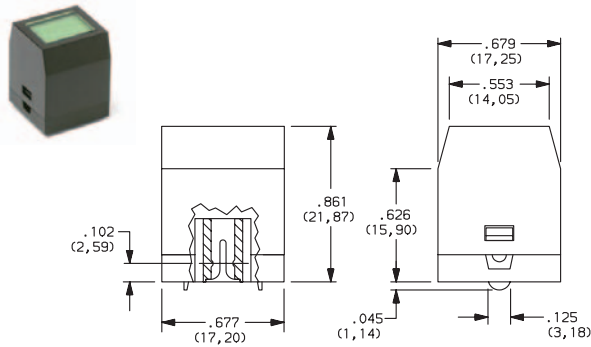

**F07** FA120

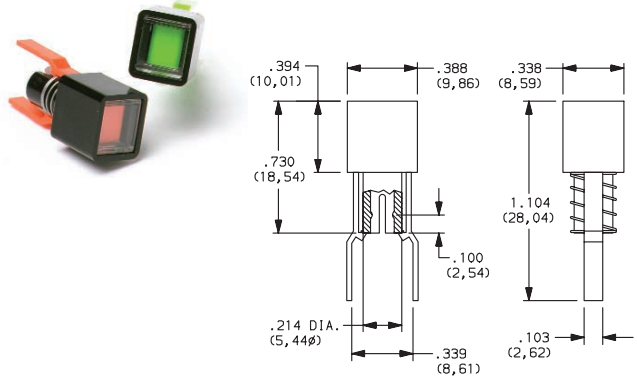

**F08** FA201

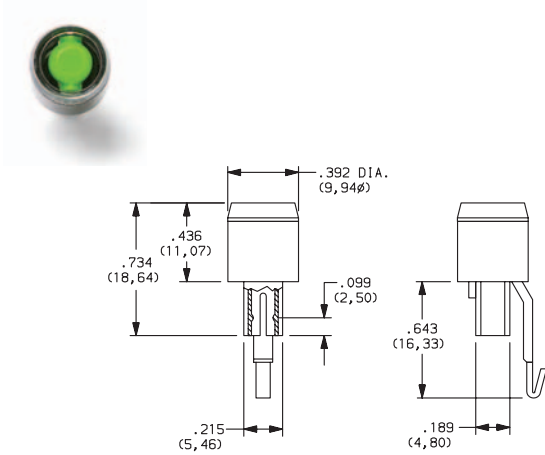

**F11** FA200

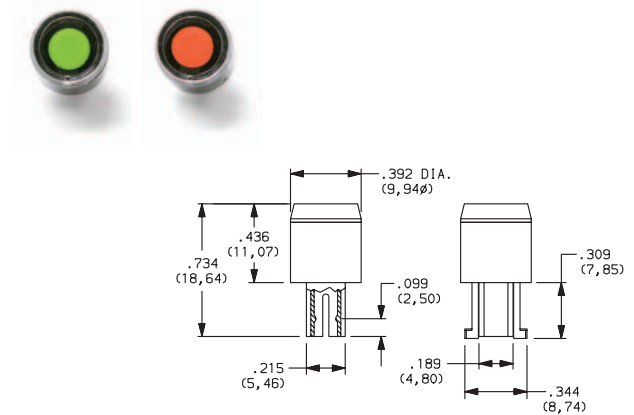

### SHELL COLOR

**01** (STD.) BLACK

### IN POSITION COLOR

OPTION CODE	COLOR
<b>02</b>	WHITE
<b>06</b>	YELLOW
<b>07</b>	BLUE
<b>08</b>	GREEN
<b>12</b>	ORANGE

### OUT POSITION COLOR

**01** (STD.) BLACK



Third Angle  
Projection  
Dimensions are shown: IN (mm)  
Dimensions subject to change



# C&K F Series Pushbutton Switches

## ILLUMINATED BUTTON WITH CHASSIS

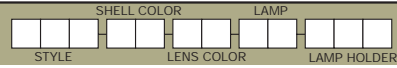

A

Pushbutton

### STYLE

**F21** FRV

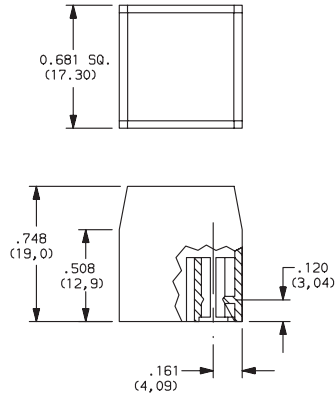

**F22** FSR

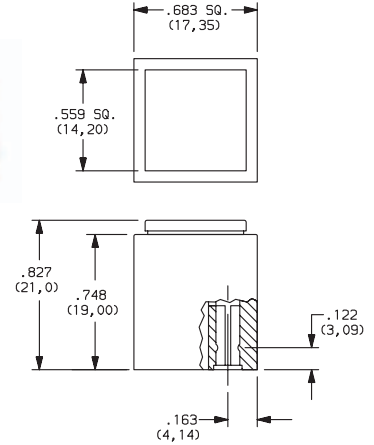

### SHELL COLOR

**01** (STD.) BLACK

### LENS COLOR

OPTION CODE	COLOR
<b>02</b>	WHITE
<b>03</b>	RED
<b>06</b>	YELLOW
<b>08</b>	GREEN
<b>12</b>	ORANGE
<b>16</b>	CLEAR / WT.

### LAMP

#### North America

OPTION CODE	LAMP
<b>01</b>	6V / 30mA
<b>02</b>	12V / 30mA
<b>03</b>	24V / 30mA

#### Europe

OPTION CODE	LAMP
<b>04</b>	5V / 60mA
<b>05</b>	6V / 40mA
<b>06</b>	12V / 40mA
<b>07</b>	24V / 20mA

### LAMP HOLDER

OPTION CODE	DESCRIPTION
<b>FL1</b>	Standard version. No electrical connection to module. Lamps are illuminated by applying voltage to the solder lugs of the lampholder contacts.
<b>FL2</b>	For use only on modules with solder lugs on top face. One of the lampholder contacts is electrically linked with the module by means of a blade spring connecting the normally closed contact of the left side front changeover.



Dimensions are shown: IN (mm)  
 Dimensions subject to change

# C&K F Series Pushbutton Switches

## CENTRAL MOUNTED ILLUMINATED BUTTON

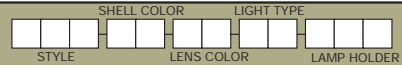

### STYLE

**F24** FLB (F200)

**F25** FLC

Pushbutton

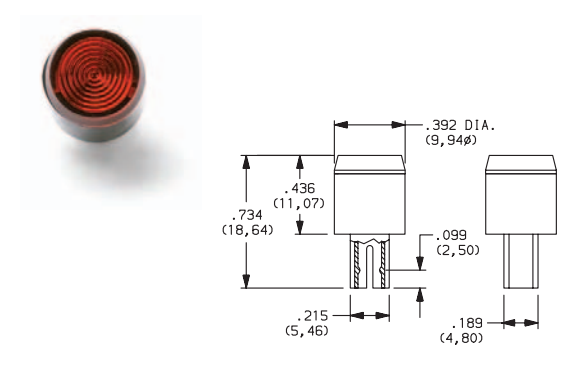
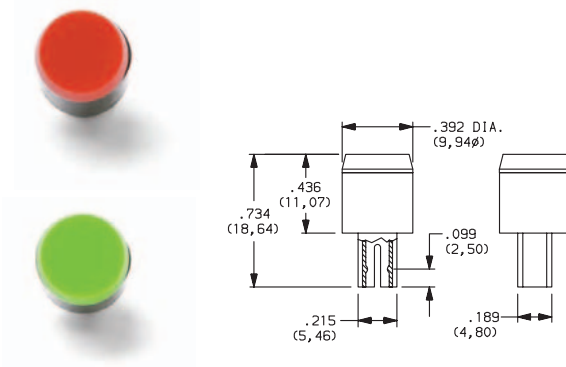

### SHELL COLOR

OPTION CODE	COLOR
<b>01</b>	(STD.) BLACK
<b>02</b>	WHITE
<b>05</b>	GRAY

### LENS COLOR

OPTION CODE	COLOR
<b>03</b>	RED
<b>06</b>	YELLOW
<b>07</b>	BLUE
<b>08</b>	GREEN
<b>12</b>	ORANGE
<b>16</b>	CLEAR / WT.

### LIGHT TYPE

OPTION CODE	DESCRIPTION
<b>01</b>	Lamp, 6V
<b>02</b>	Lamp, 12V
<b>03</b>	Lamp, 28V
<b>04</b>	LED, green
<b>05</b>	LED, red
<b>06</b>	LED, yellow
<b>07</b>	Neon, 110-220AC

### LAMP HOLDER

OPTION CODE	DESCRIPTION
<b>LZ1</b>	Illumination dependent on button position. Button depressed, lamp on.
<b>LZ2</b>	Illumination independent of button position.

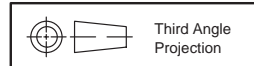

Dimensions are shown: IN (mm)  
 Dimensions subject to change

# C&K F Series Pushbutton Switches



A

Pushbutton

## CHASSIS

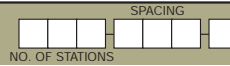

## NUMBER OF STATIONS

**C00 Thru C10** Comes with standard 0.094 (2.44mm) mounting holes

**NOTE:** Single station chassis available with mounting configurations, consult factory.

## SPACING

**00** SINGLE STATION

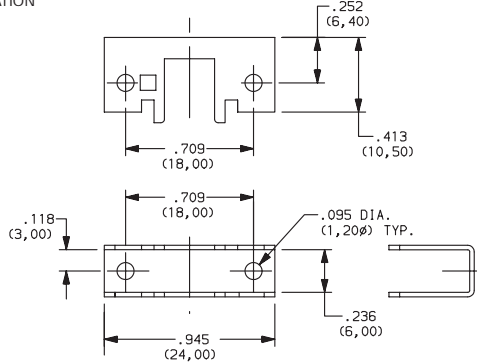

**10** 10mm

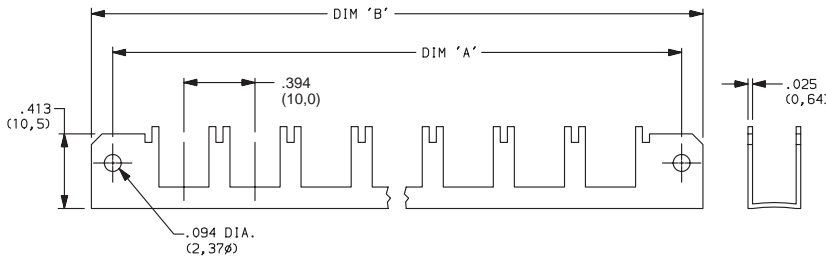

No. of Stations	Dim. 'A'	Dim. 'B'	Tolerance
2	1.182 (30,02)	1.418 (36,02)	0.005
3	1.575 (40,01)	1.811 (46,00)	0.010
4	1.969 (50,01)	2.205 (56,01)	0.010
5	2.363 (60,02)	2.599 (66,01)	0.010
6	2.757 (70,03)	2.993 (76,02)	0.015
7	3.150 (80,01)	3.386 (86,00)	0.015
8	3.544 (90,02)	3.780 (96,01)	0.015
9	3.938 (100,03)	4.174 (106,02)	0.015
10	4.331 (110,01)	4.567 (116,00)	0.015

**12.5** 12.5mm

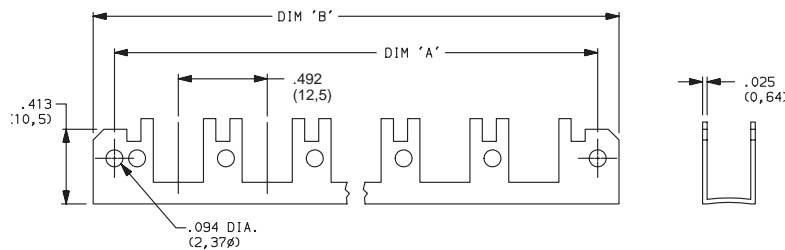

No. of Stations	Dim. 'A'	Dim. 'B'	Tolerance
2	1.200 (30,48)	1.436 (36,47)	0.005
3	1.692 (42,98)	1.928 (48,97)	0.010
4	2.184 (55,47)	2.420 (61,47)	0.010
5	2.676 (67,97)	2.912 (73,96)	0.010
6	3.169 (80,49)	3.405 (86,49)	0.015
7	3.661 (92,99)	3.897 (98,98)	0.015
8	4.153 (105,49)	4.389 (111,48)	0.015
9	4.645 (117,98)	4.881 (123,98)	0.015
10	5.137 (130,48)	5.373 (136,47)	0.015



Third Angle  
Projection

Dimensions are shown: IN (mm)  
Dimensions subject to change

# C&K F Series Pushbutton Switches



Pushbutton

CHASSIS

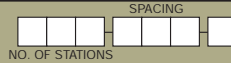

## SPACING

**15** 15mm

No. of Stations	Dim. 'A'	Dim. 'B'	Tolerance
2	1.374 (34,90)	1.615 (41,02)	0.005
3	1.969 (50,01)	2.205 (56,01)	0.010
4	2.560 (65,02)	2.796 (71,02)	0.010
5	3.150 (80,01)	3.386 (86,00)	0.010
6	3.741 (95,02)	3.977 (101,02)	0.015
7	4.332 (110,03)	4.568 (116,03)	0.015
8	4.922 (125,02)	5.158 (131,01)	0.015
9	5.513 (140,03)	5.749 (146,02)	0.015
10	6.103 (155,02)	6.339 (161,01)	0.015

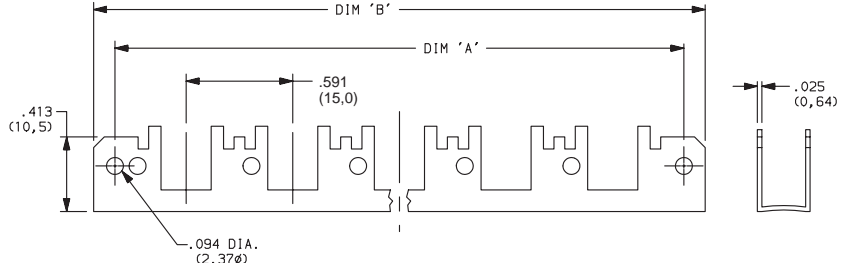

**17.5** 17.5mm

No. of Stations	Dim. 'A'	Dim. 'B'	Tolerance
2	1.477 (37,52)	1.713 (43,51)	0.005
3	2.166 (55,02)	2.402 (61,01)	0.010
4	2.855 (75,52)	3.091 (78,51)	0.010
5	3.544 (90,02)	3.780 (96,01)	0.010
6	4.233 (107,52)	4.469 (113,51)	0.015
7	4.922 (125,02)	5.158 (131,01)	0.015
8	5.611 (142,52)	5.847 (148,51)	0.015
9	6.300 (160,02)	6.536 (166,01)	0.015
10	6.989 (177,52)	7.225 (183,52)	0.015

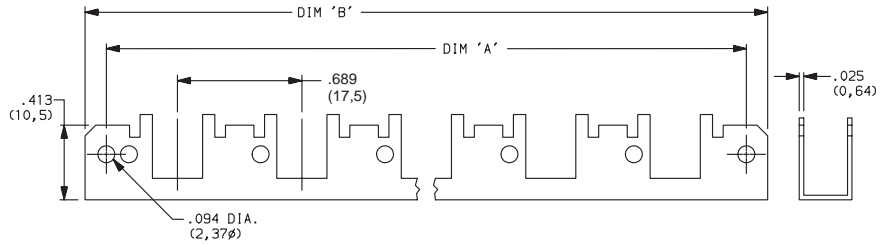

**20** 20mm

No. of Stations	Dim. 'A'	Dim. 'B'	Tolerance
2	1.575 (40,01)	1.811 (46,00)	0.005
3	2.363 (60,02)	2.599 (66,01)	0.010
4	3.150 (80,01)	3.386 (86,00)	0.010
5	3.938 (100,03)	4.174 (106,02)	0.010
6	4.725 (120,02)	4.961 (126,01)	0.015
7	5.512 (140,00)	5.748 (146,00)	0.015
8	6.300 (160,02)	6.536 (166,01)	0.015
9	7.087 (180,01)	7.323 (186,00)	0.015
10	7.875 (200,03)	8.111 (206,02)	0.015

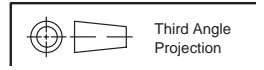
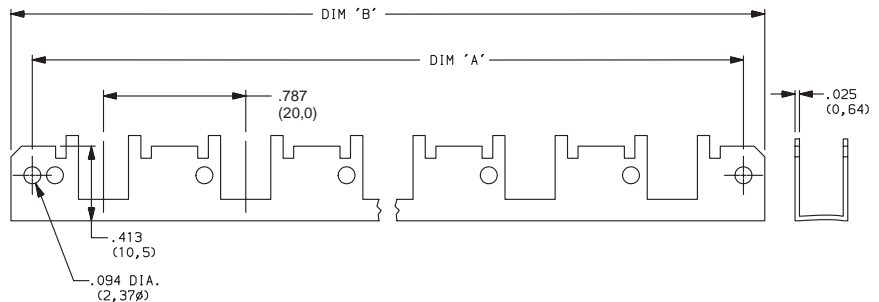

Dimensions are shown: IN (mm)  
Dimensions subject to change