

Am186ES MICROCONTROLLER BLOCK DIAGRAM

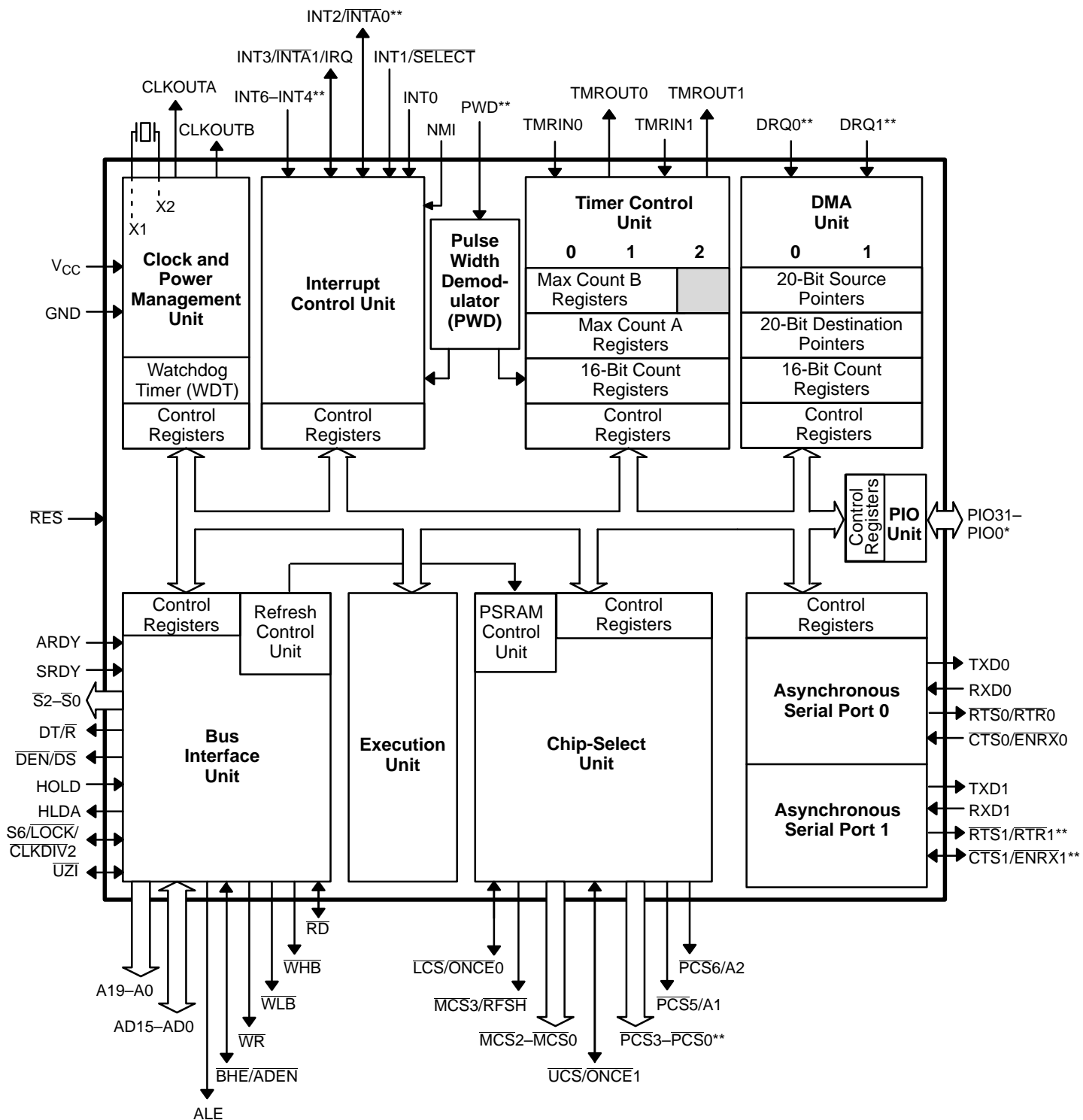

Notes:

* All PIO signals are shared with other physical pins. See the pin descriptions beginning on page 29 and Table 2 on page 35 for information on shared functions.

** PWD, INT5, INT6, RTS1/RTR1, and CTS1/ENRX1 are multiplexed with INT2/INTA0, DRQ0, DRQ1, PCS3, and PCS2 respectively. See the pin descriptions beginning on page 29.